



Important suggestions to examiners:

- 1) The answers should be examined by key words and not as word-to-word as given in the model answer scheme.
- 2) The model answer and the answer written by candidate may vary but the examiner may try to assess the understanding level of the candidate.
- 3) The language errors such as grammatical, spelling errors should not be given more importance. (Not applicable for subject English and communication skills)
- 4) While assessing figures, examiner may give credit for principle components indicated in a figure. The figures drawn by candidate and model answer may vary. The examiner may give credit for any equivalent figure drawn.
- 5) Credits may be given step wise for numerical problems. In some cases, the assumed constant values may vary and there may be some difference in the candidate's answers and model answer.
- 6) In case some questions credit may be given by judgment on part of examiner of relevant answer based on candidate understands.
- 7) For programming language papers, credit may be given to any other program based on equivalent concept.

Q.1 A)	Attempt any THREE :	12 Marks
a)	Enlist any two functions of bearings. State and explain the types of bearings.	
Ans:	(Function of bearings 2 Marks, Types of bearing 1 Mark, Explain 1 Mark, Total 4 Marks)	
	<u>Function of bearing:</u> (Any two points are expected)	(2 Marks)
	1. It supports the rotating part of machine.	
	2. It helps to maintain moving member of a machine to a fixed physical location, relative to stationary part.	
	3. It helps moving component to rotate with reduced friction.	
	4. It reduces noise	
	<u>Types of Bearings:</u>	(1 Mark)
	1. Ball or Roller Bearing	
	2. Sleeve or bush Bearing (It is made from bronze)	



Explanation:- (Any two points are expected) (1 Mark)

Advantages of ball or roller Bearing:

1. Low running and starting friction i.e. friction loss is less.
2. It produces less noise.
3. Maintenance cost is low.
4. Long Life.
5. It occupies less space.

Application of ball or roller Bearing:

1. It is used for I.M because friction loss is less, hence we can keep air gap between stator and rotor minimum and kept constant.
2. It is used for shaft position other than horizontal to take axial thrust.

Disadvantages of sleeve bearing:

1. Large friction loss
2. It produces noise
3. Maintenance cost is more,
4. Lubricating oil is compulsory and it must be checked and replaced after six months

Application:-

1. Motors with sleeve bearings are always used with horizontal shaft.

b) State the advantages and applications of dielectric heating.

Ans: **(Advantages 2 Marks, Applications 2 Marks, Total 4 Marks)**

Advantages of Dielectric Heating:- (Any two points are expected) (2 Marks)

- 1) This is only method for heating non-metallic material. (Di-electric)
- 2) Bad conductor of heat material can be heat by this method (for e.g. porcelain)
- 3) As no flame or arc exists in the process, so material like plastic, wood cotton etc. heated safely.



- 4) As heat is produced inside material to be heated due to dielectric loss, so time required for heating is less.
- 5) As there is no heat transfer loss so efficiency is high.
- 6) Uniform heating is possible.
- 7) Temperature control is easy by simply controlling voltage & frequency.
- 8) Clean and convenient method.
- 9) Operation is simple and automatic.

Applications of Dielectric Heating:- (Any two points are expected)

(2 Marks)

- 1) In wood industry for manufacturing of ply wood.
- 2) In plastic Industry for making different containers.
- 3) For manufacturing process of raincoats & umbrellas.
- 4) In medical lines for sterilization of instruments & bandages.
- 5) For quick drying gum used for book binding purpose.
- 6) In cotton industry for drying & heating cotton cloths for different processes.
- 7) For Rubber vulcanizing, tyre and tube manufacturing process
- 8) Cooking of food without removing outer shell (e.g.-boiled egg)
- 9) In milk industry for pasteurizing of milk.
- 10) In Tobacco manufacturing industry for dehydration of tobacco.
- 11) In food processing industry, dielectric heating is used for Baking of cakes & biscuits in bakeries.



c)	Define : (i) Luminous intensity (ii) Illumination (iii) Space to height ratio (iv) Luminous efficiency (Each definition 1 mark , Total 4 Marks)
Ans:	<p>i) Luminous intensity:- (1 Mark)</p> $\text{Luminous intensity} = \text{Illumination} = \frac{\text{Luminous Flux}}{\text{Area}}$ <p>OR $I = \frac{\phi}{w}$ (Where $\phi = \text{luminous flux}$, $w = \text{Solid Angle}$)</p> <p style="text-align: center;">OR</p> <p>The luminous intensity in any particular direction is the luminous flux emitted by source per unit solid angle is called the luminous intensity of the source.</p> <p>ii) Illumination:- (1 Mark)</p> <p>When light falls on surface, it becomes visible, this phenomenon is called as illumination OR The illumination is defined as the luminous flux falling on per unit area of the given surface on the working plane</p> $\text{Illumination} = \frac{\text{Luminous Flux}}{\text{Area}} \text{ lumens/ m}^2$ <p style="text-align: center;">Unit-Lux</p> <p>iii) Space-Height ratio: (1 Mark)</p> <p>It is the ratio of space between two lamps to height of lamp above working plane.</p> $\text{Space height ratio} = \frac{\text{Space between two lamps}}{\text{Height of the lamp above working plane}}$ <p>iv) Lamp η (lamp efficiency):- (1 Mark)</p> <p>It is defined as the ratio of the total luminous flux emitting from the source to Its electrical power input in watts.</p> <p style="text-align: center;">OR</p> $\text{Luminous efficiency} = \frac{\text{total luminous flux emitting from the source}}{\text{electrical power input}}$



d) Enlist any four disadvantages of low power factor.

Ans:

(Any four disadvantages 1 Mark each, Total 4 Marks)

We know that,

$$P = \sqrt{3} V_L I_L \cos\phi$$

- For same power to be transmitted at same voltage over a same distance

$$I \propto \frac{1}{\cos\phi} \propto \frac{1}{P.f}$$

- From above equation it is seen that as power factor decreases current increases, due to increase in current, system has following disadvantages

Disadvantages of Low power Factor: -

1) Cross section of conductor increases: -

$$C/s \text{ of conductor} \propto I \propto 1/(pf)$$

As power factor reduces current increases, cross section of conductor increases. Hence its cost increases.

2) Weight of conductor increases:-

As cross section of conductor increases its weight increases

3) Design of supporting structure: -

As weight of conductor increases design of supporting structure becomes heavier, so its cost increases.

4) Cross section of terminals increases: -

As power factor reduces, current increases, Hence cross section of switch gear, bus bar, contacts, and terminals increases. So its cost increases.

5) Copper losses increases: -

As power factor reduces current increases. So copper losses increases. As an effect efficiency reduces.

$$\text{Copper losses} \propto I^2 \propto \frac{1}{(P.f)^2}$$



6) Voltage drop increases: -

As P.F. reduces current increases. Therefore voltage drop increases, so regulation becomes poor.

$$\text{Voltage drop} \propto I \propto \frac{1}{\text{P. f}}$$

7) Handling Capacity of equipment reduces:

Handling capacity (KW) of each equipment such as Alternator, transformer reduces as power factor reduces.

8) High KVA rating of equipment required:- $KVA \propto I \propto 1/pf$,

As power factor decreases KVA rating of all equipments increases, so that its cost increases.

$$\text{KVA rating} \propto I \propto \frac{1}{\text{P. f}}$$

9) Cost/unit increases: - From all above disadvantages it is seen that cost of generation, transmission & distribution increases. Also its performance efficiency & regulation reduces, So that cost/unit increases.

10) Energy bill (KWH) increases:-

So at low P.F. energy consumption increases so energy bill increases

$$\text{KWH} \propto I \propto 1/\text{Cos}\phi$$

So at low P.F. KVA demand (M.D. charges) increases so energy bill increases

$$\text{KVA} \propto I \propto 1/\text{Cos}\phi$$

Q.1B) Attempt any ONE : **6 Marks**

a) With the help of neat figure, describe the regenerative braking for D.C. shunt motor.

Ans: Regenerative braking:- **(5 Marks)**

- At the time of braking motors are made to work as a generator & generated electrical energy is fed back to supply wire.
- In this way instead of wasting kinetic energy during braking it is converted into



electrical energy hence its name is regenerative braking.

- Regenerative braking is only possible when train is going down the gradient exceeding 0.6 %.
- Excitation current is so adjusted that generated voltage (E_g) is greater than supply voltage (V), so that power will be fed back to supply.
- It is possible to generate voltage greater than supply voltage only when D.C motor field winding is separately excited and extra care must be taken to make it more stable.

Regenerative braking Of DC Shunt motor:

(1 Mark)

In this method, instead of being disconnected from the supply, it remains connected and returns the braking energy to the line. Consider a shunt motor running as shown in Fig. Suppose the load causes the speed to be increased above normal, the field current remaining the same then the back e.m.f. becomes greater than the supply voltage ($E_b > V$).

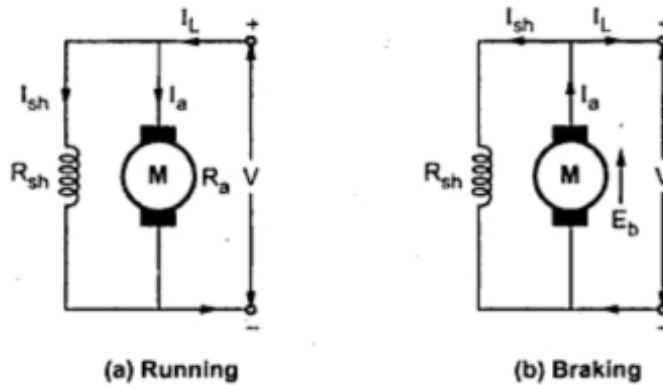

or equivalent figure

b) With the help of neat figure, explain ultrasonic welding. State its applications.

Ans: Figure ultrasonic welding:-

(2 Marks)

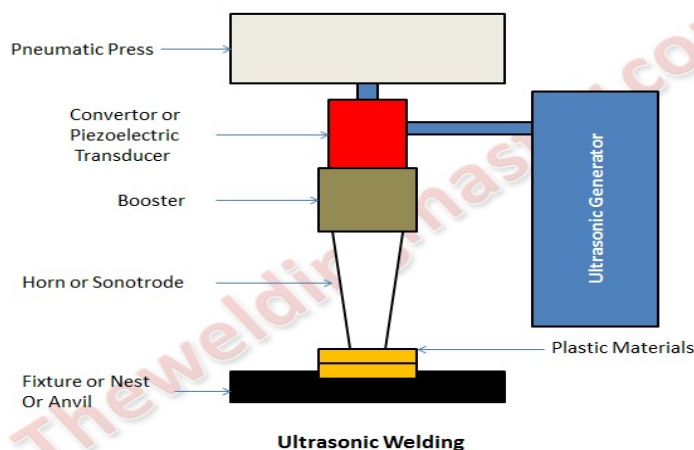

or equivalent Figure



	<p>Working Principle:- (2 Marks)</p> <p>A high frequency (20 kHz to 40 kHz) ultrasonic vibration is used to join two plastic pieces together. The high frequency vibration generates heat energy at the interface of the two pieces and melts the material. The melted material fused with each other to form a strong weld on cooling and solidification.</p> <p>Application:- (2 Marks)</p> <ol style="list-style-type: none">1. It is most commonly used to weld thermoplastic materials and dissimilar materials.2. Metal with thin section can also be welded.
Q.2	Attempt any FOUR : 16 Marks
a)	What is group drive? State its four disadvantages.
Ans:	<p style="text-align: center;">(What is group drive 2 Mark .disadvantages 1/2 Mark each, Total 4 Marks)</p> <p>Group drive: - (2 Marks)</p> <p>In a group drive single large capacity electric drives is used to run number of machines through a long common shaft is known as group drive.</p> <p>Disadvantages of Group drive:- (Any four disadvantages 1/2 Mark each, Total 2 Marks)</p> <ol style="list-style-type: none">1. Flexibility:- Flexibility is lost due to common shaft for number of machines.2. Safety:- It is less safe.3. Reliability:- Its reliability is less at the time of breakdown and maintenance of single large motor, Because, all the machines operations are required to be shut down at the time of breakdown and maintenance of single large motor.4. Mechanical power transmission losses:- Considerable power loss takes place for transfer of mechanical energy from shaft to machine.



5. Speed control:-

Speed control of individual machine is difficult, it requires special arrangement.

6. Addition / Alteration:-

Possibility of addition or alteration in existing system is limited.

7. Efficiency and Power Factor: -

If group drive is run at reduced load then Efficiency and Power Factor of group drive will be less.

b) What are the requirements to heating elements materials? Enlist four names of heating material.

Ans:

(Requirements 2 Marks, Names of heating material 2 Marks, Total 4 Marks)

Following requirements of heating material:-

(Any Four requirements are expected ½ Mark each, Total 2 Marks)

1. High resistivity:

It should have high resistivity. So that it becomes compact in size and produces more heat with small input current.

2. High melting point:

It should have high melting point to withstand at high temperature.

3. High Resistance to corrosion:

It should have high resistance to corrosion to avoid rusting.

4. Brittleness -

It should not be brittle.

5. High Oxidizing temperature:

It should have high oxidizing temperature or it should not oxidize even at high temperature.

6. High Mechanical Strength:

It should have high mechanical strength to withstand from mechanical injury.



7. Ductile:

It should be ductile so that it can be manufactured into different size & shape.

8. Long Life:

It should have long life.

9. Less Costly:

It should be less costly and easily available.

10. Low temperature co-efficient of resistance:

For accurate temperature control, it should have low temperature co-efficient of resistance.

Names of Material used for manufacturing of heating element:-

(Any Four Names of Material are expected ½ Mark each, Total 2 Marks)

- i) Nichrome (Nickel-chromium) ii) Constantan or Eureka (Nickel-copper) iii) Kanthal (Iron-chromium-Aluminum) iv) Nickel-chromium-iron v) Carbon vi) Tungsten vii) Platinum viii) Silicon carbonate ix) Iron-chromium-Aluminum

Refer the Fig. below, which is a speed time curve of a train and answer the questions :

(i) The curve is of which type of train service.

(ii) Give the names of following time periods : (I) $0 - t_1$ (2) $t_2 - t_3$ (3) $t_4 - t_5$

c)

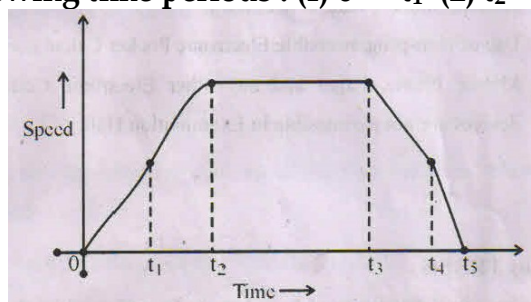

Ans: i) The curve is of which type of train service:- Main line services

(1 Mark)

ii) Names of following time periods :

(1) $0 - t_1$:- Acceleration Period

(1 Mark)

(2) $t_2 - t_3$:- Free running Period

(1 Mark)

(3) $t_4 - t_5$:- Braking Period

(1 Mark)



d) State and explain in short any four desirable characteristics of traction motors.

Ans:

(Any Four characteristics are expected 1 Mark each, Total 4 Marks)

Traction motor should possess Following Characteristics:-

- 1) It should have high starting torque.
- 2) It should possess high rate of acceleration & retardation.
- 3) Its speed-torque characteristics should be such that it should produce high torque at low speed and low torque at high speed.
- 4) It should be variable speed motor so motor is capable of taking excessive overload.
- 5) It should have simple speed control methods.
- 6) It should withstand for voltage fluctuation without affecting its performance.
- 7) It should have high power to weight ratio.
- 8) Weight of motor per HP should be minimum in order to increase payload capacity.
- 9) It must be small in overall dimensions, especially in overall diameter.
- 10) It should have less maintenance cost.
- 11) It should have high efficiency.
- 12) It should have long life
- 13) It should be simple in design
- 14) It should be robust in construction to withstand against continuous vibrations.
- 15) It must have totally enclosed type enclosure to provide protection against entry of dirt, dust, mud, water etc. in drive.
- 16) When motors are running in parallel they should share almost equal load. (even when there is unequal wear & tear of driving wheels)
- 17) It should have high coefficient of adhesion.



- 18) It should have lower center of gravity.
- 19) Electrical braking system should be reliable, easy to operate and control, especially regenerative braking is possible.
- 20) Motor should draw low inrush current (Starting current, and if supply is interrupted and restore again.)
- 21) It should have low initial cost.

e) Draw the diagram of AC electric locomotive and explain the function of each part

Ans:

(Diagram 2 Marks, function of each part 2 Marks, Total 4 Marks)

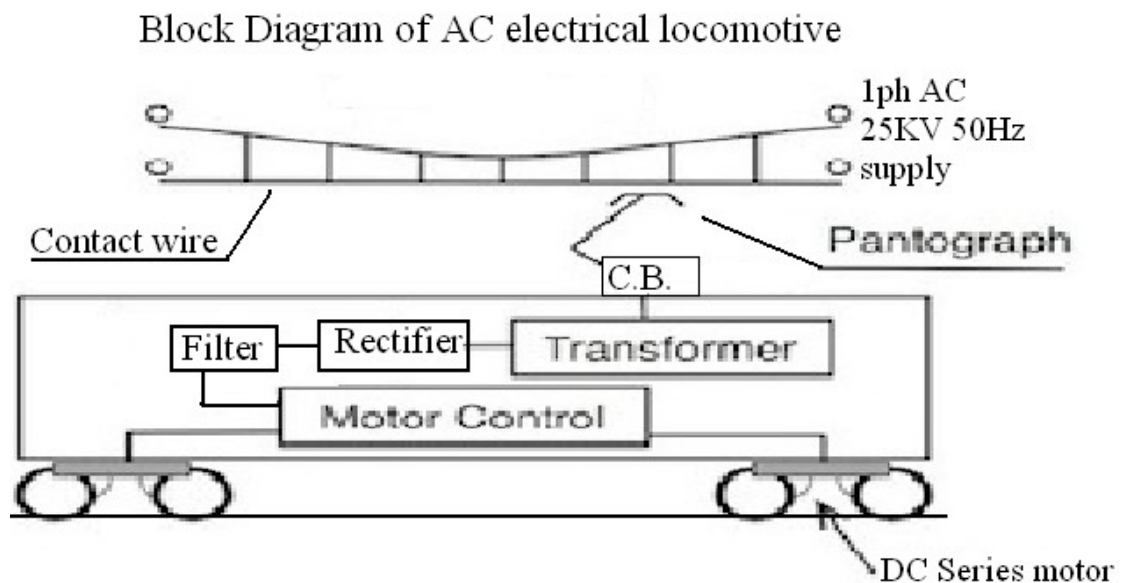

OR Equivalent Figure

Explanation:

1) Overhead contact wire:

Supply of 1-ph, 25KV, 50Hz, AC is given to overhead conductor.

2) Current collecting device:

It collects current from overhead contact wire and passes it to tap changing transformer through circuit breaker.



	<p>3) Circuit breaker (C.B):</p> <ul style="list-style-type: none">➤ It is connected in between current collecting devices and tap changing transformer. SF6 circuit breaker is used.➤ To disconnect locomotive equipment's whenever there is fault.➤ It opens automatically when train passes neutral zone (from zone No.1 to Zone No.2) <p>4) On load tap changing transformer /Tapping transformer:</p> <p>It changes the tap without disconnecting the load on transformer. Its purpose is to vary the voltage for speed control of traction motor.</p> <p>Traction Transformer:</p> <p>It step down input voltage 25 KV to working voltage of traction motor (1500V/3000V).</p> <p>5) Rectifier:</p> <p>It converts secondary voltage of transformer into DC supply.</p> <p>6) Filter circuit (smoothing reactor):</p> <p>It is used to obtain pure DC supply.</p> <p>7) Motor control unit:</p> <p>It controls operation of traction motor.</p> <p>8) Traction Motor:</p> <p>It gives mechanical power to run the train DC series motor is used as traction motor.</p>	
Q.3	Attempt any TWO :	16 Marks
a)	A certain motor has to perform the following duty cycle : (i) 100 kW for 10 min (ii) 50 kW for 8 min (iii) No load for 10 min (iv) 150 kW for 5 min The above duty cycle is repeated continuously. Assuming heating is proportional to square of the current, calculate the suitable size of a motor fitting the above requirement in HP.	
Ans:	$\text{Continuous rating of motor} = \sqrt{\frac{(KW_1^2) \times t_1 + (KW_2^2) t_2 + (KW_3^2) t_3 + (KW_4) \times t_4}{T}} \text{ ----- (1 Mark)}$ <p>Where, $T = t_1 + t_2 + t_3 + t_4$</p>	



WINTER- 2018 Examinations

Subject Code: 17507

Model Answer

Page 14 of 32

$$T = 10 + 8 + 10 + 5$$

$$T = 33 \text{ min.} \text{-----} \text{Answer-----} \quad (2 \text{ Mark})$$

$$\text{Continuous rating of motor} = \sqrt{\frac{(100)^2 \times 10 + (50)^2 \times 8 + (0)^2 \times 10 + (150)^2 \times 5}{33}} \quad (1 \text{ Mark})$$

$$\text{Continuous rating of motor} = \sqrt{\frac{100000 + 20000 + 112500}{33}}$$

$$kW = 83.93 \text{ kW} \quad \text{-----} \text{Answer-----} \quad (2 \text{ Marks})$$

$$W = 83930 \text{ watt}$$

$$\text{Continuous rating of motor in HP} = \frac{83930}{735.5}$$

$$\text{Continuous rating of motor in HP} = 114.11 \text{ HP} \quad \text{-----} \text{Answer-----} \quad (2 \text{ Marks})$$

Nearest standard rating of motor is to be selected.

b) Explain with neat sketch the construction, working principle and two applications of "Ajax Wyatt" vertical core furnace.

Ans: Neat Sketch of "Ajax Wyatt" Vertical core furnace : (1 Mark)

(Neat sketch 1 Mark, construction 2 Mark, working principle 4 Mark, Applications 1 Mark, Total 8 Marks)

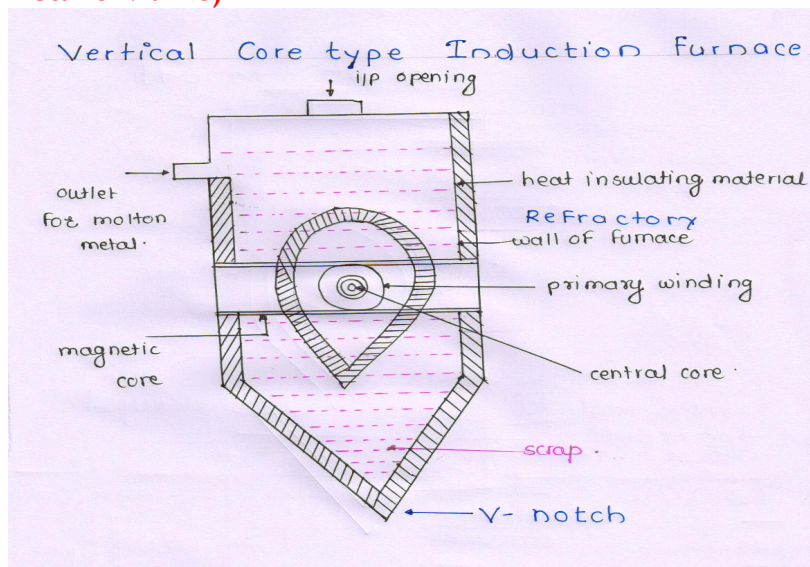

or equivalent Figure



Principle of Induction heating:

(4 Mark)

It is based on principle of transformer. In this type of Induction heating primary winding is as usual which is wound around one limb of magnetic core but secondary winding is actually charge which is to be melted is kept in crucible.

When AC Supply is given to primary winding current flows through primary winding which creates alternating flux in magnetic core this flux links to the secondary winding i.e. charge through magnetic core. Hence according to faraday's law of electromagnetic induction emf will be induced in secondary winding that is in the charge.

As charge forms a close circuit (secondary) heavy current flows through charge this current is responsible to produce heat in charge due to I^2R losses. This heat is utilized to melt the charge.

Where, R = Resistance of charge & I secondary current.

Construction of 'Ajax Wyatt' vertical core type furnace:

(2 Mark)

'Ajax Wyatt' type induction heating furnace is nothing but transformer. **It consists of:-**

- a. Magnetic Core
- b. Primary winding
- c. Secondary Winding
- d. Refractory Wall
- e. Opening (There are two opening to the furnace.)
- f. Cooling arrangement
- g. Tilting arrangement
- h. Control panel
- i. APFC panel

Applications:- (Any two applications 1/2 mark each)

(1 Mark)

1. For melting copper, copper alloys such as brass, bronze and zinc
2. It is used for melting metal having low resistivity
3. It is used for heat treatment of silver, Copper, nickel etc.



c)	With proper justification suggest suitable enclosures to be used for electric drives in following locations of industries. (i) Chemical plant (non-explosive) (ii) General industrial installation (non-explosive) (iii) Mines or others hazardous locations (iv) General outdoor installation.
Ans:	justification suggest suitable enclosures to be used for electric drives in following locations of industries: (i) Chemical plant (non-explosive):- (2 Marks) ➤ Totally enclosed or Drip proof or moisture proof or equivalent (ii) General industrial installation (non-explosive):- (2 Marks) ➤ Totally enclosed type or pipe ventilated totally enclosed type or equivalent (iii) Mines or others hazardous locations:- (2 Marks) ➤ Fire (flame) proof type enclosure or equivalent or totally enclosed type. (iv) General outdoor installation:- (2 Marks) ➤ Totally enclosed type or pipe ventilated totally enclosed type or equivalent
Q.4A)	Attempt any THREE : 12 Marks
a)	State any four requirements of good welding.
Ans:	(Any four requirements are expected 1 Mark each, Total 4 Marks) The good welding has following requirements:- 1) Welding joints must be strong and reliable 2) Joint (welding) is made by proper welding technique. 3) Welds should have a reasonably smooth, uniform & consistent appearance. 4) Welding Should be free from any type of welding defects 5) To avoid oxidation welds should have an adequate shielding from the atmosphere (Oxygen) 6) Welding should be done by only skilled welder 7) Correct welding technic should be used 8) The joint preparation of work pieces to weld should be done properly.



- 9) The electrode of correct type and size should be used
- 10) According to the nature of job welding current should be selected.
- 11) In case of pressure welding, pressure should be correctly control in time.
- 12) In case of arc welding proper arc length should be maintained.

b) State and explain the law of inverse squares in illumination.

Inverse Square Law:-

(4 Marks)

Intensity of illumination produced by a point source varies inversely as square of the distance from source.

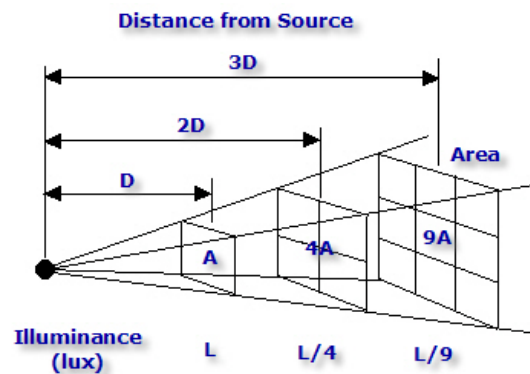

or equivalent figure

OR

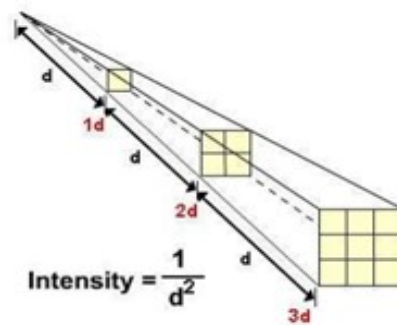

or equivalent figure

Ans:

$$E = \frac{I}{d^2}$$

$$E \propto \frac{1}{d^2}$$

Where,

I = intensity and d = Distance



c) Compare two part tariff and three part tariff.

Ans: (Any four points from following or equivalent are expected 1 mark each , Total 4 Marks)

Sr.No	Two Part Tariff	Three part Tariff
1	Energy bill is divided into Two parts	Energy bill is divided into three parts
2	Energy bill = Fixed charge + Running charge	Energy bill = Fixed charge + Semi fixed charge + Running charge
3	Fixed charge is directly proportional to maximum demand in KW	Fixed charge is directly proportional to connected load.
4	No semi fixed charge	Semi fixed Charge directly proportional to maximum demand in KVA
5	It is used for LT consumer/residential	It is used for HT consumer/industrial

d) What are advantages of power factor improvement? (any four)

Ans: (Any four advantages from following or equivalent are expected 1 mark each , Total 4 Marks)

We know that,

$$P = \sqrt{3} V_L I_L \cos\phi$$

- For same power to be transmitted at same voltage over a same distance

$$I \propto \frac{1}{\cos\phi} \propto \frac{1}{P.f}$$

- From above equation it is seen that as power factor increases current decreases, due to decreases in current, system has following advantages



1. Cross section of conductor reduces:

$$\text{Cross section of conductor } \propto I \propto \frac{1}{\text{P. f}}$$

As P.F. increases current reduce so; cross section of conductor and its weight reduces hence its cost reduces

2. Weight of conductor decreases:-

$$\text{Weight of conductor } \propto I \propto \frac{1}{\text{P. f}}$$

As cross section of conductor reduces its weight reduces.

3. Design of supporting Structure:

As weight of conductor reduces design of supporting structure (tower) becomes lighter, so its cost reduces.

4. Cross section of terminal (contacts) reduces:

As power factor increases, current reduces. Hence cross section of switchgear bus bar and contacts etc decreases.

5. Copper losses reduces:

As power factor increases current reduces. So copper losses reduces. As an effect efficiency increase.

$$\text{Copper losses } \propto I^2 \propto \frac{1}{(\text{P. f})^2}$$

6. Voltage drop reduces:

As P.F. increases, current decreases. So voltage drop decreases, So regulation gets improved (better)

$$\text{Voltage drop } \propto I \propto \frac{1}{\text{P. f}}$$



7. Handling capacity (KW) of equipment increases:

As power factor increases, handling capacity of each equipment such as Alternator, transformer increases.

8. KVA rating of equipment's reduces:

As P.F. increases, current decreases. So KVA rating of all equipment's for e.g.- alternator, transformer etc. decreases, so its capital cost reduces.

$$\text{KVA rating} \propto I \propto \frac{1}{\text{P. f}}$$

9. Cost per unit (KWH) reduces:

From all above advantages, it is seen that cost of generation, transmission & distribution decreases, so cost/unit reduces.

Also performance i.e. efficiency & regulation gets improved at high power factor.

10. Energy bill (KWH consume) reduces:-

So at high P.F. energy consumption reduces so energy bill reduces.

$$\text{KWH} \propto I \propto 1/\text{Cos}\phi$$

So at low P.F. KVA demand (M.D. charges) reduces so energy bill reduces

$$\text{KVA} \propto I \propto 1/\text{Cos}\phi$$

Q. 4 B)	Attempt any ONE :	6 Marks
a)	What is resistance welding ? Write its principle of operation. Applications (any two) and write its classification also.	
Ans:	(What is resistance welding 1 Mark, principle of operation 1 Mark, Applications (any two) 1 Mark classification 3 Marks, Total 6 Marks)	
	What is resistance welding:-	(1 Mark)
	In this process welding is obtain by heating the metallic part to a plastic state & then joining them together <u>by applying external pressure</u> is known as resistance	



welding. This type of welding is done without adding external filler material.

Principle of operation resistance welding:-

(1 Mark)

In resistance welding, sufficiently heavy current at low voltage is passed directly through two metals in contact to be welded.

Heat is produced due to I^2R losses where 'R' is the contact resistance. This heat is utilized to obtain welding temperature (to become a plastic state)

When welding temperature is reached supply is cut down and external pressure is applied simultaneously across the job to complete weld.

According to joules law,

$$\text{Heat produced } H = I^2 R t \dots\dots\dots \text{ Watt-sec}$$

From this equation it is clear that heat produced depends on

- Square of current (I^2)
- Contact resistance (R)
- Duration of current (t)

Hence to obtain more heat in less time high current is necessary.

Applications:- (Any two applications are expected from following)

(1 Mark)

a) Applications of spot welding:-

- 1) Joining of automobile body section.
- 2) Joining sheet metal structure.
- 3) It is used for automatic welding process.
- 4) For spot welding to GI sheets, MS sheet, tinned, lead-coated sheets.
- 5) For spot welding to non-ferrous material such as brass, bronze, nickel, Cu,Al,etc.
- 6) In fabrication workshop for different applications.

OR

b) Applications of Seam welding:-

It gives leak-proof joints.

1. Hence used for welding of various types of containers,
2. Pressure tank,



3. Tank of transformer,
4. Gas line,
5. Air craft tank,
6. Condenser,
7. Evaporator and
8. Refrigerator etc.

OR

c) Applications of Projection welding:-

- 1) For cross-wire welding.
- 2) Used for attachments of nut-bolts, stud, ring etc.

OR

d) Application Butt Welding:

- 1) For welding rod, wire, pipe etc
- 2) Butt welding is a resistance welding process for joining thick metal plates or bars at end

OR

e) Application Flash Butt welding:

- 1) For welding rod.
- 2) For weld shaft
- 3) Rail, ends
- 4) For welding chains

Classification resistance welding:-

(3 Marks)

Resistance Welding:-

- 1) Spot welding
- 2) Seam welding
- 3) Projection Welding
- 4) Butt Welding
- 5) Flash Butt welding



b)	An industrial unit has maximum demand of 250 kW with a load factor of 0.6. The following tariffs are offered: (i) Two part tariff? 70/kW of MD/year + 4 paisa/kWh (ii) A flat rate tariff of 10 paisa/kWh. Which tariff is cheaper?
Ans:	<p>➤ No. of Units consume in One Year</p> $= \text{Load Factor} \times M.D(KW) \times 8760 \quad \text{----- (1/2 Mark)}$ $= 0.6 \times 250 \times 8760$ $= 1314000 \text{ Kwh} \quad \text{----- (1 Mark)}$ <p>➤ Case-I: Energy Bill :-</p> $= (\text{Tariff given Rs. 70 of M.D. / year} + \text{Rs. 4 paise / Kwh}) \quad \text{----- (1/2 Mark)}$ $= (250 \times 70) + (1314000 \times 4/100)$ $= (\text{Rs. 17500} + \text{Rs. 52560})$ $= 70060 \text{ Rs.} \quad \text{----- (1 Mark)}$ <p>➤ Case-II: Energy Bill :-</p> $= (\text{Tariff given flat rate of 10 Paise / Kwh}) \quad \text{----- (1 Mark)}$ $= (1314000 \times 10/100)$ $= 131400 \text{ Rs.} \quad \text{----- (1 Mark)}$ <p>Remark:- ----- (1 Mark)</p> <p>Two part tariff will be cheaper i.e. 70/kW of MD/year + 4 paisa/kWh because power consumption is less</p> <p style="text-align: center;">OR</p> <p>➤ According to energy bill Case-I is economical</p> <p>➤ For industrial consumer Case-I is economical</p>



Q.5 Attempt any FOUR : (16 Marks)

a) With the help of neat sketch, explain construction and working principle of sodium vapour lamp.

Ans: (Neat sketch 1 Mark , construction 1.5 Marks, working principle 1.5 Marks , Total 4 Marks)

Sodium Vapour Lamp diagram: (1 Mark)

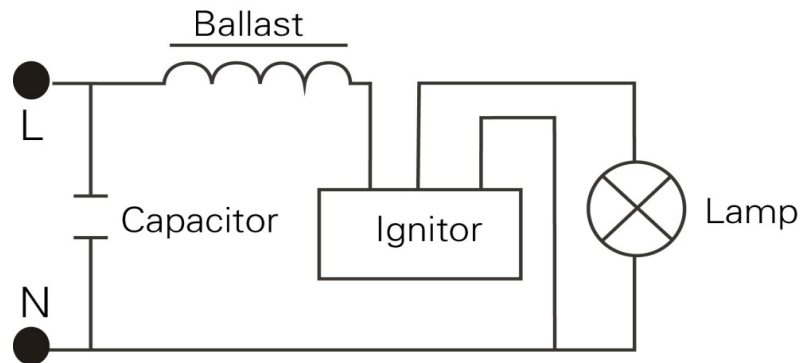

OR

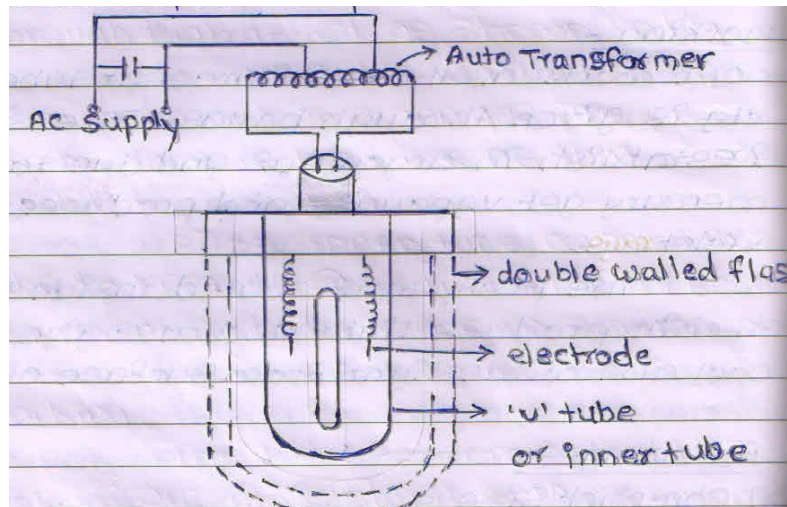

OR Equivalent figure

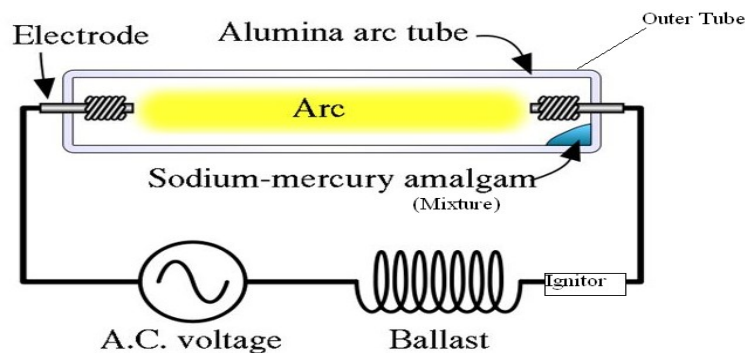



Construction:-

(1.5 Mark)

- HPS lamps consist of an arc tube (inner) enclosed by an outer tube.
- Vacuum is created between the inner & outer glass tube to prevent heat loss.
- The arc tube is made from a special glass that can withstand to high temperatures
- Arc tube is U Shape
- The arc tube contains xenon / neon gas (starting gas), sodium and mercury and two electrodes.
- It require a ballast to give high voltage at starting to produce the arc
- There is an igniter which sends a pulse to start the discharge.
- To improve the power factor a capacitor is connected across the supply. (P.F. is low @ 0.3 lag.)
- HPS lamps do not have starting electrodes.

Working Principle:

(1.5 Mark)

- When the lamp is turned on, a high voltage at starting is applied across two electrodes, to initiate an arc which discharges and vaporizes xenon /neon gas (starting gas), sodium and mercury.
- The energized metal atoms emit light.
- After 2 to 5 minutes lamp will glow 100 %.
- For running the lamp low voltage of about 165 v is sufficient.
- The color of light produce is yellowish.

b) State any four safety features to be observed in welding work.

Ans: **Following are safety features observed in welding work:-**

(Any Four from following or equivalent Safety Features expected: 1 Mark each ; Total 4 Marks)

1. Select clothing to welder to provide maximum protection from spark & hot metals
2. Flame proof skull cap.
3. Hand held helmet with filter lens.
4. Safety shoes (Leather)
5. Fire resistant hand gloves.
6. Clean fire resistance clothing : i) Shirt full sleeves ii) No pockets iii) Collar buttoned



- iv) Long pants with no cuff v) Leather Apron
- 7. Dust Mask
- 8. Hearing Protection
- 9. PPE (Personal Protective equipment)
- 10. First aid kit
- 11. Class 'C' fire extinguishers
- 12. Other equipment's like small hammer, file, small metal wire brush etc. are essential during welding.
- 13. Earthing clamp and proper earthing arrangement

c) **How speed control of traction motor is done using shunt transition method.**

Ans: **speed control of traction motor is done using shunt transition method:**

(Each step 1 Mark, Total 4 Marks)

In Shunt transition, speed control, is carried out by following step

Transition Steps

Step1: Re insert starting resistances in motor circuit No.1.

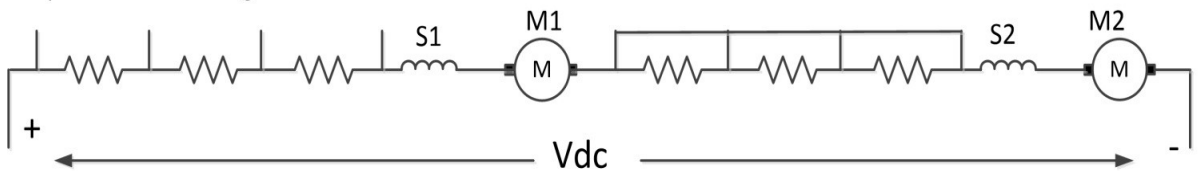

Step2: Short circuit motor No.2 as shown in figure

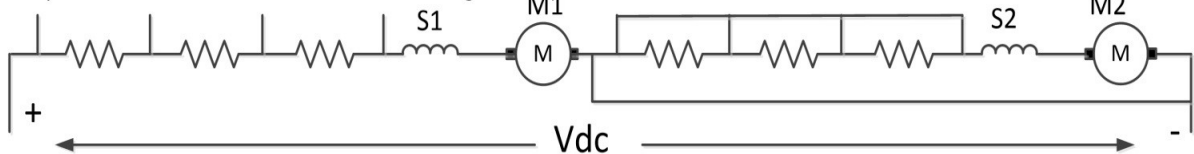

Step 3 – Open one end of short circuit motor & reinsert starting resistance in motor circuit No.2.

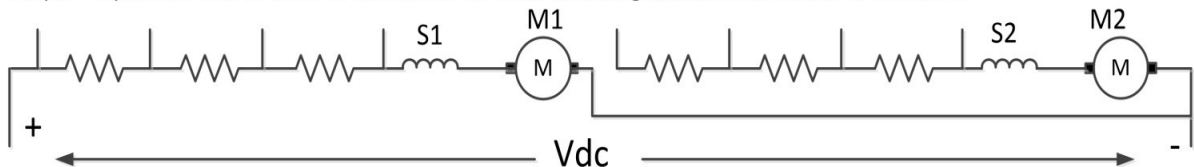

Step 4 –Connect open end of motor to supply terminal (positive). This is nothing but parallel first step.

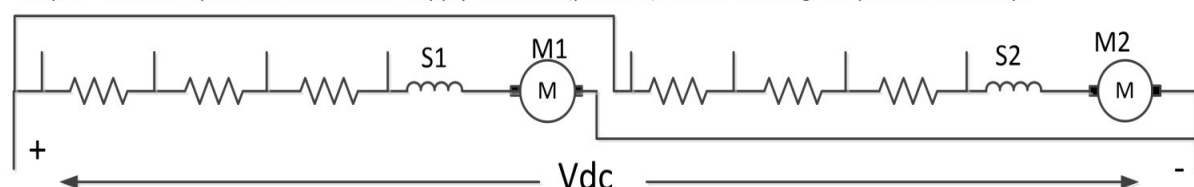



d)	Define schedule speed and state any four factors affecting schedule speed.
Ans:	<p style="text-align: right;">(Define 2 Marks, factors affecting schedule speed 2 Marks, Total 4 Marks)</p> <p>Schedule Speed: - (2 Marks)</p> <p>It is defined as distance covered between two stops divided by schedule time is known as schedule speed. OR</p> $\text{Schedule Speed} = \frac{\text{Distance between stops or stations}}{(\text{Actual time of run}) + (\text{Stop time})} \quad \text{Km/hr}$ $\text{Schedule Speed} = \frac{\text{Distance between stops or stations}}{\text{Schedule time}}$ <p>The following factors affect the schedule speed:-</p> <p style="text-align: right;">(Four factors affecting schedule speed are expected 1/2 Mark each , Total 2 Marks)</p> <ol style="list-style-type: none">1. By increasing acceleration2. By increasing retardation3. By increasing both acceleration and retardation4. By increasing maximum speed5. By reducing stop time6. By reducing coasting period
e)	Why DC series motor is preferred for traction applications? Justify your answer with characteristics.
Ans:	<p style="text-align: right;">(Characteristics 1 Mark, For justification points 3 Marks, Total 4 Marks)</p> <p>Due to following characteristics and advantages, DC series motor is suitable for traction duty:</p> <ol style="list-style-type: none">1) Characteristics: (1 Mark) <div style="text-align: center;"><p>Characteristics of DC series motor</p></div>



Advantages/ **Justification points:-**

(Any six points are expected 1/2 Mark each, Total 3 Marks)

1. DC Series motor has high starting torque.
2. DC Series motor has high rate of acceleration and retardation.
3. DC series motor has speed- Torque characteristics is such that it produces high torque at low speeds, low torque at high speed.
4. DC Series motor is variable speed motor. Due to these characteristics motor is protected against overload i.e. self -reliving property against over load
5. It has high power to weight ratio.
6. DC series motor consumes less power than AC motors for same HP
7. DC Series motor maintenance cost is less.
8. DC series motor weight is 1.5 times less than 1-Ph AC series motor for same H.P.
9. Torque is unaffected by variation in supply voltage.
10. Torque obtained by DC series motor is smooth and uniform, so it improves riding quality.
11. DC Series motor robust in construction and capable to withstand against continuous vibration.
12. When DC series motor are running in parallel the all motors share almost equal load.

Q.6 Attempt any TWO : (16 Marks)

a) Enlist any four electrical equipment's and their functions, which are used in arc furnaces.

Ans: (Any four electrical equipment's are expected 2 Mark each, Total 8 Marks)

Electrical equipment's required for arc furnace:

1. Furnace Transformer:

It is ON- load tap changing transformer. Its secondary winding is designed for low voltage and high current. Secondary winding has number of taps of different voltage

2. Series Reactor:



Reactor is used, for two purposes:-

- To stabilize the arc.
- To limit current short circuit.

3. Circuit Breaker (CB):

To protect the furnace transformer against various types of fault.

4. Automatic current regulator (ACR):

It adjusts current automatically flowing through electrode for control of temperature (arc).

5. Electrode:

Carbon, Graphite electrode are used.

6. Connecting rod:

It is used for making connection from secondary of transformer to electrode.

It carries very high current. So it consists of heavy copper rod or strip.

7. APFC: To improve the P.F. of furnace automatically to the most economical P.F.

b) A trapezoidal time curve of a train consists of (i) uniform acceleration of 6 kmphs for 25 sec. (ii) Free running for 10 min (iii) Uniform deceleration of 6 kmphs for stopping the train. (iv) Stop time of 5 min. Find the distance between the stations, average speed and schedule speed.

Ans: **Given Data:**

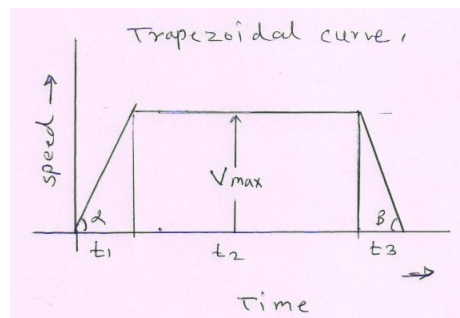

$t_1 = 25 \text{ sec}$ $t_2 = 10 \text{ min} = 600 \text{ sec}$ $T_{\text{stop}} = 5 \text{ min} = 300 \text{ sec}$
acceleration $\alpha = 6 \text{ km phs}$ retardation $\beta = 6 \text{ km phs}$

➤ $\alpha = \frac{V_{\text{max}}}{t_1}$ ----- (1/2 Mark)



$$V_{\max} = t_1 \times \alpha = 25 \times 6$$

$$V_{\max} = 150 \text{ Km/hr} - \text{-----Answer----- (1/2 Mark)}$$

➤ $\beta = \frac{V_{\max}}{t_3} - \text{----- (1/2 Mark)}$

$$t_3 = \frac{V_{\max}}{\beta} = \frac{150}{6}$$

$$t_3 = 25 \text{ sec} - \text{-----Answer----- (1/2 Mark)}$$

➤ Distance covered during Acceleration ($D\alpha$) =

$$D\alpha = \frac{V_{\max}^2}{7200\alpha} - \text{----- (1/2 Mark)}$$

$$D\alpha = \frac{(150)^2}{7200 \times 6}$$

$$D\alpha = 0.52083 \text{ km} - \text{-----Answer----- (1/2 Mark)}$$

Distance covered during Retardation ($D\beta$) =

$$D\beta = \frac{V_{\max}^2}{7200\beta} - \text{----- (1/2 Mark)}$$

$$D\beta = \frac{(150)^2}{7200 \times 6}$$

$$D\beta = 0.52083 \text{ km} - \text{-----Answer----- (1/2 Mark)}$$

$$\therefore D \text{ Free running} = \frac{t_2 \times V_{\max}}{3600} - \text{----- (1/2 Mark)}$$

$$D \text{ Free running} = \frac{600 \times 150}{3600}$$

$$D \text{ Free running} = 25 \text{ Km} - \text{-----Answer----- (1/2 Mark)}$$



$$Distance 'D' = D\alpha + D\beta + D \text{ Free running}$$

$$Distance 'D' = 0.52083 + 0.52083 + 25$$

$$Distance 'D' = 26.04168 \text{ Km} \text{ -----Answer----- (1/2 Mark)}$$

OR

Student may calculate distance by using following formula also consider

$$V_{\max} = \frac{T - \sqrt{T^2 - 4K3600D}}{2K} \text{ -}$$

$$K = \frac{\alpha + \beta}{2(\alpha \times \beta)} \text{ ---}$$

$$Time 'T' = t_1 + t_2 + t_3 = 25 + 600 + 25$$

$$Time 'T' = 650 \text{ Sec} \text{ -----Answer----- (1/2 Mark)}$$

$$\Rightarrow V_{av} = \frac{3600 D}{Time} \text{ ----- (1/2 Mark)}$$

$$V_{av} = \frac{3600 \times 26.04168}{650}$$

$$V_{av} = 144.2308 \text{ Km / hr} \text{ -----Answer--- (1/2 Mark)}$$

$$\Rightarrow V_{schv} = \frac{3600 D}{T + T_{stop}} \text{ ----- (1/2 Mark)}$$

$$V_{schv} = \frac{3600 \times 26.04168}{650 + 300}$$

$$V_{schv} = 98.6842 \text{ Km / hr} \text{ -----Answer----- (1/2 Mark)}$$

c) An industrial unit consumes 250 kW at 110 V from a 3 phase supply and pf of 0.80 lagging. A synchronous motor is installed which takes an additional 120 kW. What must be the kVA rating of this motor to raise the pf of the system to 0.9 lagging ?

Ans:

Given Data:

$$P_L = 250 \text{ KW, } \cos\phi = 0.8 \text{ } \tan\phi_1 = 0.75$$

$$Power \text{ factorto be improved to } 0.9 \text{ lag } \tan\phi_2 = 0.4843$$

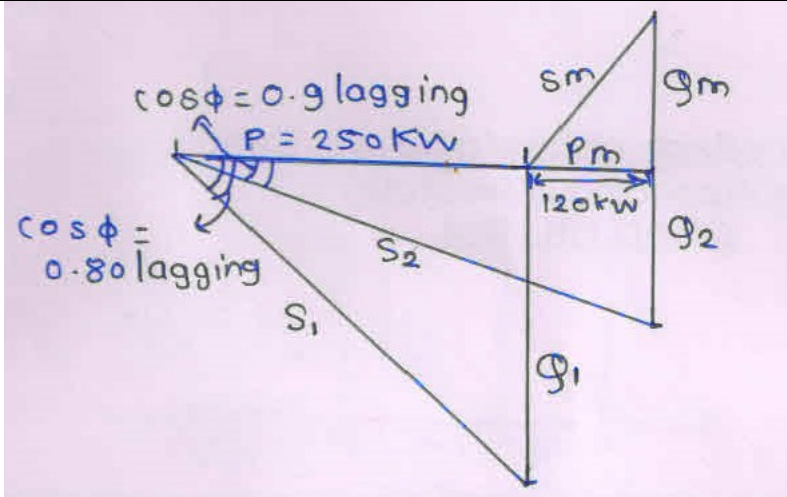

----- (1 Mark)

➤ Reactive Power taken by load (Q_1) = $P_1 \tan \phi_1$ ----- (1 Mark)

$$= 250 \times 0.75$$

$$= 187.5 \text{ KVAR} \quad \text{----- (1Mark)}$$

Reactive Power taken after synchronous motor is connected (Q_2) =

$$= (P_L + P_m) \tan \phi_2 \quad \text{----- (1 Mark)}$$

$$= (250 + 120) \times 0.4843$$

$$= 179.191 \text{ KVAR} \quad \text{----- (1 Mark)}$$

➤ Reactive Power taken by synchronous motor to improve P.f =

$$= (Q_1 - Q_2)$$

$$= 187.5 - 179.191$$

$$= 8.309 \text{ KVAR (leading)} \quad \text{----- (1 Mark)}$$

➤ KVA Rating of Synchronous Motor $S_m = \sqrt{(P_m + \phi_m)^2}$ - ----- (1 Mark)

$$V_{schv} = \sqrt{(120)^2 + (8.309)^2}$$

$$S_m = 120.2873 \text{ KVA} \quad \text{---- (1 Mark)}$$