



**Important Instructions to examiners:**

- 1) The answers should be examined by key words and not as word-to-word as given in the model answer scheme.
- 2) The model answer and the answer written by candidate may vary but the examiner may try to assess the understanding level of the candidate.
- 3) The language errors such as grammatical, spelling errors should not be given more importance (Not applicable for subject English and Communication Skills).
- 4) While assessing figures, examiner may give credit for principal components indicated in the figure. The figures drawn by candidate and model answer may vary. The examiner may give credit for any equivalent figure drawn.
- 5) Credits may be given step wise for numerical problems. In some cases, the assumed constant values may vary and there may be some difference in the candidate's answers and model answer.
- 6) In case of some questions credit may be given by judgement on part of examiner of relevant answer based on candidate's understanding.
- 7) For programming language papers, credit may be given to any other program based on equivalent concept.

Q. No .	Sub Q. N.	Answer	Marking Scheme
1	A	<b>Attempt any <u>SIX</u> of the following.</b>	<b>12</b>
	(a)	<b>What is ferrous metal? Give any two examples of it.</b>	<b>02</b>
	Ans	<b>Ferrous metal: (Definition 1 Mark)</b> It contains iron as the main constituent. It has magnetic properties, good machinability, good mechanical properties and easy availability.  <b>Example: (Any two-½ marks each)</b> a) Cast Iron b) Wrought Iron c) Alloy steels d) Die steels	<b>01</b>  <b>01</b>
	(b)	<b>Classify plain carbon steel.</b>	<b>02</b>
	Ans	Classification of plain carbon steel: 1. Low Carbon Steels: Composition: 0.008% to 0.30% Carbon and remaining iron with impurities.  2. Medium Carbon Steels: Composition: 0.30% to 0.60% Carbon and remaining iron with impurities.  3. High Carbon Steels: Composition: 0.60% to 2.0% Carbon and remaining iron with impurities.	<b>02</b>



	<b>(c)</b>	<b>What is 18-4-1 H.S.S?</b>	<b>02</b>
	<b>An s</b>	18-4-1 H.S.S. is a high speed tool steel. It contains 18 % Tungsten, 4 % Chromium, 1 % Vanadium With 0.75 % Carbon & Remaining Iron.	<b>02</b>
	<b>(d)</b>	<b>What is thermoplastic? Give any two examples.</b>	<b>02</b>
	<b>An s</b>	<b>Thermoplastics: (1 Mark)</b> Plastics which can be easily softened again and again by heating. They can be reprocessed safely. They retain their plasticity at high temperature. They can be heated and reshaped by pressing many times. On cooling they become hard. They can be easily shaped into tubes, sheets, films and many other shapes as per the need.  Examples of Thermoplastic: <i>(Any 02- 1/2 mark each)</i> 1. Polythene 2. Polypropylene 3. Polystyrene 4. Nylon 5. Acrylics 6. Polycarbonates 7. Acrylonitrile butadiene styrene 8. Polyvinylchloride	<b>01</b>         <b>01</b>
	<b>(e)</b>	<b>List any four types of cast iron</b>	<b>02</b>
	<b>An s</b>	Types of cast iron: <i>(Any 04- 1/2 mark each)</i> 1. Cupola cast irons 2. Air furnace cast irons 3. Electric furnace cast irons 4. Duplex cast irons 5. Low carbon, low silicon cast irons 6. High carbon, low sulphur cast irons 7. Nickel alloy cast irons 8. Grey cast irons 9. White cast irons 10. Malleable cast irons 11. Nodular cast irons /Ductile Cast iron/Spheroidal cast iron 12. Mottled cast irons 13. Chilled cast irons 14. Meehanite cast	<b>02</b>
	<b>(f)</b>	<b>Write any two purposes of heat treatment</b>	<b>02</b>
	<b>An</b>	<b>Purposes of heat treatment processes: <i>(Any Two)</i></b> i. To soften the steel that has been hardened by the previous heat treatment or	



s	mechanical working. ii. To harden the steel and increase its strength. iii. To adjust its other mechanical and physical properties like ductility, malleability, permeability corrosion resistance, etc. iv. To stabilize the dimensions of the steel instruments so that they do not expand or contract with time. v. To refine the grain size of the steel and to reduce internal stresses. vi. To improve machinability & weldability. vii. To improve mechanical properties e.g. tensile strength, ductility, hardness, shock resistance, resistance to corrosion etc. viii. To relieve internal stresses induced during hot or cold working. ix. To improve magnetic and electrical properties. x. To improve heat resistance, wear resistance.	02
(g)	<b>State two functions of gating systems.</b>	02
Ans	Functions of Gating system in case of casting:(Any 02) 1. To provide continuous, uniform feed of molten metal, with as little turbulence as possible to the mould cavity. 2. To supply the casting with liquid metal at best location to achieve proper directional solidification and optimum feeding of shrinkage cavities. 3. To fill the mould cavity with molten metal in the shortest possible time to avoid temperature gradient. 4. To provide with a minimum of excess metal in the gates and risers. Inadequate rate of metal entry, on the other hand, will result many defects in the casting. 5. To prevent erosion of the mould walls. 6. To prevent slag, sand and other foreign particles from entering the mould.	02
(h)	<b>Enlist types of cutting tools.</b>	02
Ans	<b>A) Depending upon number of cutting points on the tool:</b> i) Single point cutting tool – tools employed on lathes, boring machines, shaper, planer etc. ii) Multi-point cutting tool – twist drill, tap, reamer, milling cutter, broach, end mill cutters etc. <b>B) Depending upon construction of cutting tool:</b> i) Solid tools ii) Tipped cutting tools	02



**MODEL ANSWER**

**WINTER- 18 EXAMINATION**

**Subject Title: Materials and Manufacturing Processes**

Subject Code:

**17306**

<b>1</b>	<b>B</b>	<p><b>Attempt any <u>TWO</u> of the following.</b></p>	<b>08</b>																					
	<b>(a)</b>	<p>Differentiate between gray cast iron and white cast iron.(any four points)</p>	<b>04</b>																					
		<p><b>Difference between grey cast iron and white cast iron: (Any 04)</b></p> <table border="1" style="width: 100%; border-collapse: collapse;"> <thead> <tr> <th style="width: 25%;">Criteria</th> <th style="width: 50%;">Grey Cast Iron</th> <th style="width: 25%;">White Cast Iron</th> </tr> </thead> <tbody> <tr> <td><b>Production</b></td> <td>Obtained by melting pig iron, coke and steel scrap in cupola furnace and allowing it to cool and solidify slowly.</td> <td>Obtained by melting pig iron, coke and steel scrap in cupola furnace and allowing it to cool and solidify rapidly.</td> </tr> <tr> <td><b>Presence of Carbon</b></td> <td>The iron contains carbon in the form of graphite flakes.</td> <td>While solidifying, the iron contains carbon in the form of iron carbide</td> </tr> <tr> <td><b>Surface colour</b></td> <td>Dull grey crystalline or granular structure. Strong light will give a glistering effect due to reflection of free graphite flakes.</td> <td>Its broken surface shows a bright white fracture. Its fractured surface appears white because of absence of graphite and hence the name white cast iron.</td> </tr> <tr> <td><b>Machinability</b></td> <td>It has good machinability.</td> <td>It has poor machinability and mechanical properties.</td> </tr> <tr> <td><b>Wear Resistance</b></td> <td>High resistance to wear.</td> <td>The material is having excellent wear resistance.</td> </tr> <tr> <td><b>Applications</b></td> <td>Used for machine structure, engine frames, drainage pipes, pistons of I.C. engines, bed of lathe machine.</td> <td>Used for wearing plates, road roller surface, grinding balls, dies and extrusion nozzles.</td> </tr> </tbody> </table>	Criteria	Grey Cast Iron	White Cast Iron	<b>Production</b>	Obtained by melting pig iron, coke and steel scrap in cupola furnace and allowing it to cool and solidify slowly.	Obtained by melting pig iron, coke and steel scrap in cupola furnace and allowing it to cool and solidify rapidly.	<b>Presence of Carbon</b>	The iron contains carbon in the form of graphite flakes.	While solidifying, the iron contains carbon in the form of iron carbide	<b>Surface colour</b>	Dull grey crystalline or granular structure. Strong light will give a glistering effect due to reflection of free graphite flakes.	Its broken surface shows a bright white fracture. Its fractured surface appears white because of absence of graphite and hence the name white cast iron.	<b>Machinability</b>	It has good machinability.	It has poor machinability and mechanical properties.	<b>Wear Resistance</b>	High resistance to wear.	The material is having excellent wear resistance.	<b>Applications</b>	Used for machine structure, engine frames, drainage pipes, pistons of I.C. engines, bed of lathe machine.	Used for wearing plates, road roller surface, grinding balls, dies and extrusion nozzles.	<b>04</b>
Criteria	Grey Cast Iron	White Cast Iron																						
<b>Production</b>	Obtained by melting pig iron, coke and steel scrap in cupola furnace and allowing it to cool and solidify slowly.	Obtained by melting pig iron, coke and steel scrap in cupola furnace and allowing it to cool and solidify rapidly.																						
<b>Presence of Carbon</b>	The iron contains carbon in the form of graphite flakes.	While solidifying, the iron contains carbon in the form of iron carbide																						
<b>Surface colour</b>	Dull grey crystalline or granular structure. Strong light will give a glistering effect due to reflection of free graphite flakes.	Its broken surface shows a bright white fracture. Its fractured surface appears white because of absence of graphite and hence the name white cast iron.																						
<b>Machinability</b>	It has good machinability.	It has poor machinability and mechanical properties.																						
<b>Wear Resistance</b>	High resistance to wear.	The material is having excellent wear resistance.																						
<b>Applications</b>	Used for machine structure, engine frames, drainage pipes, pistons of I.C. engines, bed of lathe machine.	Used for wearing plates, road roller surface, grinding balls, dies and extrusion nozzles.																						
	<b>(b)</b>	<p><b>State different alloys of copper. State its important properties.</b></p>	<b>04</b>																					
	<b>Ans</b>	<p><b>Alloys of Copper ( Any 2 of the followings - ½ mark each)</b></p> <p>1) Brass (Copper –zinc)</p> <p style="margin-left: 20px;">a) α-brass: Cap copper ,Gliding metal , Cartridge brass, Admiralty brass</p> <p style="margin-left: 20px;">b)α-β brass: Muntz metal ,Naval brass , High tensile brass, Leaded brass ,Brazing brass</p> <p>2) Bronze: Phosphor bronze ,Aluminum bronze , silicon bronze ,Tin bronze, Manganese bronze</p> <p>3) Gun metal</p> <p>4) Babbitt metal ( Copper-tin –Antimony)</p> <p><b>Properties of Copper Alloys: (Any three 01 mark each)</b></p> <p>1) High thermal &amp; Electrical conductivity</p> <p>2) Good Corrosion resistance</p>	<b>01</b>																					



		3) Soft & Nonmagnetic 4) High strength 5) Good Malleability 6) Good Ductility 7) Pleasing reddish colour 8) Easy to cast ,forged, rolled 9) Wear resistance 10) Good fatigue resistance 11) Light in weight	<b>03</b>
	<b>(c)</b>	<b>Write composition and applications of gun metal</b>	<b>02</b>
	<b>Ans</b>	Composition of gun metal: 2 to 5% of zinc (Zn), 5 to 10% of tin (Sn) and remainder is copper.  Applications of Gun Metal: ( <i>Any 04 – ½ mark each</i> ) 1. Gun barrels, 2. Ordnance parts, 3. Marine castings, 4. Gears, 5. Bearings 6. Steam pipe fittings 7. Small valves	<b>02</b>
<b>2</b>		<b>Attempt any <u>FOUR</u> of the following.</b>	<b>16</b>
	<b>a)</b>	<b>Define an alloy steel. Write the effect of any two alloying element on steel.</b>	<b>04</b>
	<b>Ans</b>	Alloy steel: It contains iron & carbon as a main element. It also contains silicon, manganese, sulphur, phosphorus in different percentage. Some alloy steels contain Manganese varies up to 1 % & silicon up to 0.3 %. Some alloy steels contain manganese more than 1 % & silicon more than 0.3 %. It also contains nickel, chromium, molybdenum, vanadium in different %. These steels are called as “Alloy Steels”.  Effects of Alloying Element on steel:( <i>Any 02 - 01 Mark each</i> )  1) Nickel: i) It improves Toughness ii) It improves Tensile Strength iii) It improves Ductility iv) It improves Corrosion Resistance 2) Chromium: i) It improves Ductility ii) It is added in different proportions upto 18 % iii) Below 1.5 % addition increases Tensile Strength	<b>02</b>



- iv) 12 % addition gives high Corrosion Resistance  
v) It improves Hardenability & Toughness simultaneously
- 3) Cobalt:
- It improves Corrosion Resistance
  - It improves Thermal Resistance
  - It improves Magnetic Properties
  - It is act as a Grain Refiner
- 4) Manganese:
- Lower proportions from 1.0 to 1.5 % improves Strength & Toughness
  - Higher proportions upto 5 % improves Hardness
  - Very Higher proportions from 11 to 14 % improves very degree of Hardness
- 5) Silicon:
- It is act as a Ferritic Strengthener
  - It improves Elastic Limits
  - It improves Magnetic Property
  - It decreases Hysteresis Losses
- 6) Molybdenum:
- It improves Hardness
  - It improves Wear Resistance
  - It improves Thermal Resistance
  - It gives ability to maintain Mechanical Properties at Elevated Temperatures
- 7) Tungsten:
- It improves Hardness
  - It improves Wear Resistance
  - It improves thermal Resistance
  - It improves shock Resistance
  - It improves Magnetic Properties
  - It gives ability to maintain Mechanical Properties at Elevated Temperatures
- 8) Vanadium:
- It improves Elastic Limit
  - It improves Shock Resistance
  - It act as a Degasser when added to Molten Metal
- 9) Boron:
- It improves Toughness
  - It improves Tensile Strength
  - It improves Ductility
  - It improves Corrosion Resistance
  - It improves Hardenability
  - It is very useful when alloyed with Low Carbon Steels
- 10) Aluminium:
- It improves Tensile Strength
  - It improves Corrosion Resistance
  - It is used as a Deoxidizer
  - It improves growth of Fine Grains
  - It improves Hardness by Nitriding to form Aluminum Nitrides

**02**



**MODEL ANSWER**  
**WINTER- 18 EXAMINATION**

**Subject Title: Materials and Manufacturing Processes**

Subject Code:

17306
-------

- 11) Titanium:  
 i) It improves Corrosion Resistance  
 ii) It is good Deoxidizer  
 iii) It forms titanium carbides means improves hardness
- 12) Copper:  
 i) It improves Toughness  
 ii) It improves corrosion Resistance  
 iii) It improves Strength  
 iv) Its proportions varies from 0.2 % to 0.5 %
- 13) Niobium:  
 i) It deceases Hardenability  
 ii) It improves Impact Strength  
 iii) It improves Fine Grain Growth  
 iv) It is also called as „, Columbium

**b) Differentiate between thermoplastic and thermo setting plastic.**

**04**

**Ans** Difference between thermoplastic and thermo-setting plastic: *(Any 04 – 01 mark each)*

Sr. No.	Thermoplastics	Thermosetting
01	They can be repeated softened by heat and hardened on cooling	once hardened and set they do not softened with application of heat
02	They are formed by addition polymerization only	They are formed by condensation polymerization
03	They consist of long chain linear polymers	They have three dimensional network structure
04	They are usually soft, weak and less brittle	They are usually hard, strong and more brittle
05	They are usually soluble in some organic solvents	They are insoluble in almost all organicsolvents
06	These can be repeatedly used and have resale value	They cannot reused and do not have resale value.
07	They cannot be used at higher temperature as they will tends to soft under heat	They can be used at comparatively higher temperature without damage.

**04**

**c) Define annealing. Write four purposes of annealing.**

**04**

**Ans** **(Definition or Explanation - 2 Marks, Objectives – 2 Marks)**

**Annealing:** Annealing is a heat process whereby a metal is heated to a specific temperature above critical temperature, holding at this temperature for a sufficient time and then allowed to cool slowly. This softens the metal which means it can be cut and shaped more easily.

**02**



**MODEL ANSWER**

**WINTER- 18 EXAMINATION**

**Subject Title: Materials and Manufacturing Processes**

Subject Code:

**17306**

**OR**

It is a process of heating a metal which is in metastable or distort structural state to a temperature which will remove instability or distortion and then cooling usually at a slow rate so that at room temperature structure is stable and strain free.

**Purpose of Annealing process:(Any four ½ mark each)**

- i. To soften the metal to improve machinability.
- ii. To refine grain size and structure to improve mechanical properties.
- iii. To relieve internal stresses.
- iv. To improve gases.
- v. To modify electrical, magnetic and physical properties.
- vi. To increase ductility of metal.
- vii. To prepare the steel for further treatment.

**02**

**d) Draw the iron-iron carbide phase diagram and show all critical temp. on it.**

**04**

**Ans (Credit should be given to suitable figure showing all details such as temperature percentage of carbon and state) (Sketch 02 marks and labeling 02 marks)**

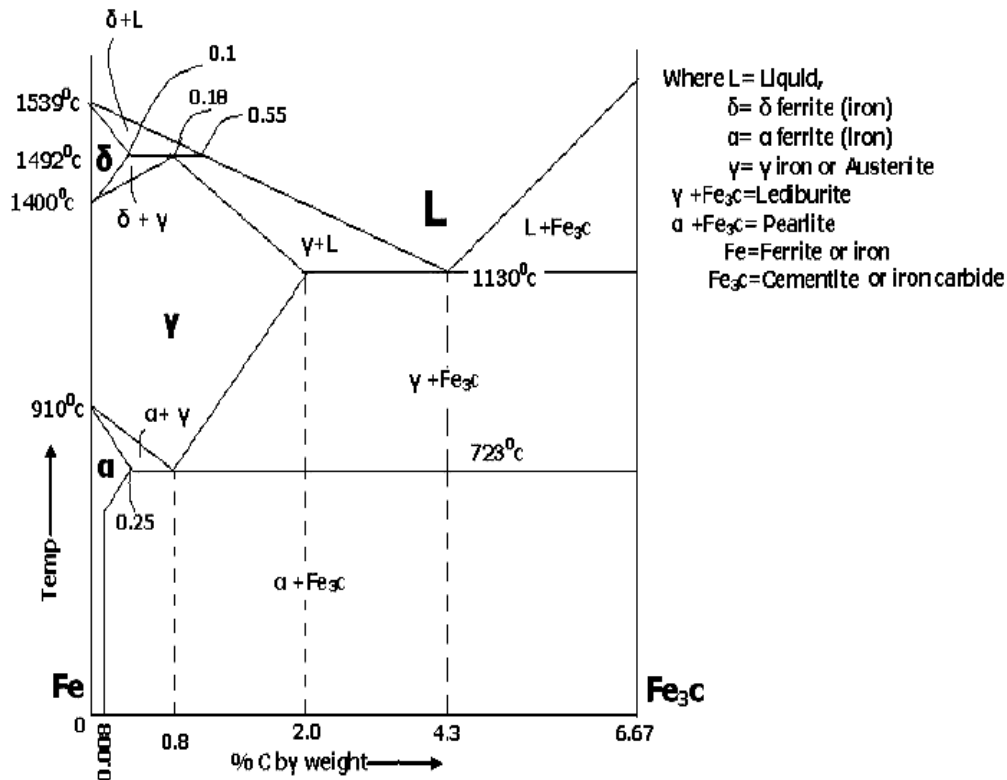

**04**





**MODEL ANSWER**

**WINTER- 18 EXAMINATION**

**Subject Title: Materials and Manufacturing Processes**

Subject Code:

<b>17306</b>
--------------

<b>e)</b>	<b>What is normalizing? State its four objectives.</b>	<b>04</b>												
<b>Ans</b>	<p><b>Normalizing: 2 marks</b> Normalizing is heating of steel to a point 40 to 500C above upper critical temperature, hold at that temperature for a short duration and subsequently cooling in still air at a room temperature.</p> <p><b>Following are the objectives of Normalizing processes: (Any Four) ( ½ mark each)</b></p> <p>i. Normalizing raises the yield point, ultimate tensile strength and impact strength values of steel. ii. To eliminate coarse-grained structure. iii. To remove internal stresses that may have been caused by previous working processes. iv. To improve the mechanical &amp; electrical properties of the steel. v. To increase the strength of medium carbon steels to a certain extent (in comparison with annealed steels) vi. To improve the machinability of low carbon steels</p>	<b>02</b>     <b>02</b>												
<b>(f)</b>	<b>Compare between flame hardening and induction hardening.</b>	<b>04</b>												
<b>Ans</b>	<p><b>any four points – 1marks each</b></p> <table border="1" style="width: 100%; border-collapse: collapse;"> <thead> <tr> <th style="width: 50%; text-align: center;">Flame Hardening</th> <th style="width: 50%; text-align: center;">Induction Hardening</th> </tr> </thead> <tbody> <tr> <td>Material is heated with oxyacetylene flame at a required temperature, and then it is followed by water spraying.</td> <td>Material is heated by using high frequency induced current and then it is followed by water spraying.</td> </tr> <tr> <td>Holding time is required.</td> <td>Due to very fast heating, no holding time is required.</td> </tr> <tr> <td>Oxidation &amp; decarburization is minimum.</td> <td>No scaling &amp; decarburization.</td> </tr> <tr> <td>Irregular shape parts can be flame hardened.</td> <td>Irregular shape parts are not suitable for induction hardening.</td> </tr> <tr> <td>Flame hardening requires more care in control of temperature.</td> <td>Easy control of temperature by control of frequency of supply voltage.</td> </tr> </tbody> </table>	Flame Hardening	Induction Hardening	Material is heated with oxyacetylene flame at a required temperature, and then it is followed by water spraying.	Material is heated by using high frequency induced current and then it is followed by water spraying.	Holding time is required.	Due to very fast heating, no holding time is required.	Oxidation & decarburization is minimum.	No scaling & decarburization.	Irregular shape parts can be flame hardened.	Irregular shape parts are not suitable for induction hardening.	Flame hardening requires more care in control of temperature.	Easy control of temperature by control of frequency of supply voltage.	<b>04</b>
Flame Hardening	Induction Hardening													
Material is heated with oxyacetylene flame at a required temperature, and then it is followed by water spraying.	Material is heated by using high frequency induced current and then it is followed by water spraying.													
Holding time is required.	Due to very fast heating, no holding time is required.													
Oxidation & decarburization is minimum.	No scaling & decarburization.													
Irregular shape parts can be flame hardened.	Irregular shape parts are not suitable for induction hardening.													
Flame hardening requires more care in control of temperature.	Easy control of temperature by control of frequency of supply voltage.													
<b>03</b>	<b>Attempt any FOUR of the following</b>	<b>16</b>												
<b>a)</b>	<b>State the different types of pattern. Explain any one with neat sketch.</b>	<b>04</b>												
	<p><i>(Different types of patterns= 02 Marks, Sketch &amp; Explanation of same with neat sketch= 01 Mark each)</i></p> <p><b>Types of patterns:</b> 1. Single piece pattern 2. Split pattern 3. Match plate pattern 4. Cope and drag pattern 5. Gated pattern 6. Sweep pattern 7. Loose piece 8. Follow board pattern Skeleton pattern 9. Segmental pattern 10. Shell pattern 11. Built-up pattern 12. Box-up pattern 13. Lagged-up pattern 14. Left &amp; right hand</p>	<b>02</b>												

**1. Solid or single piece pattern:**

It is made in one piece and carries no joints, partition or loose pieces.

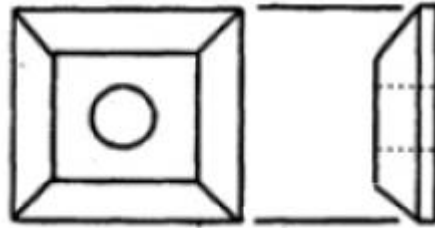

01

**2. Split or two piece patterns:** They are made in two parts and these two parts of the pattern are joined together with the help of dowel pins.

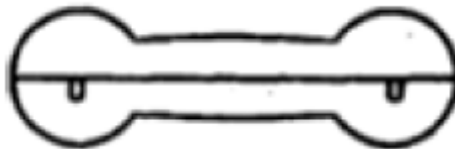

01

**3. Gated pattern:** They are used in mass production for such castings multi – cavity moulds are prepared by gate former.

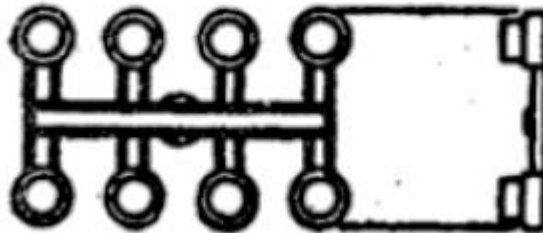

**4. Match plate pattern:** A match plate pattern is a split pattern having the cope and drag portions mounted on opposite sides of a plate (usually metallic), called the “match plate”.

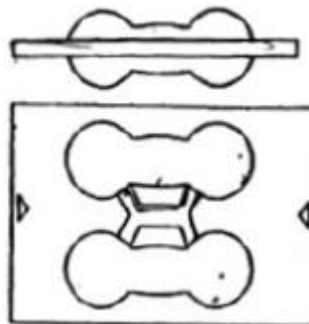

**5. Skeleton pattern:** These are simple wooden frames that outline the shape of the part to be cast.

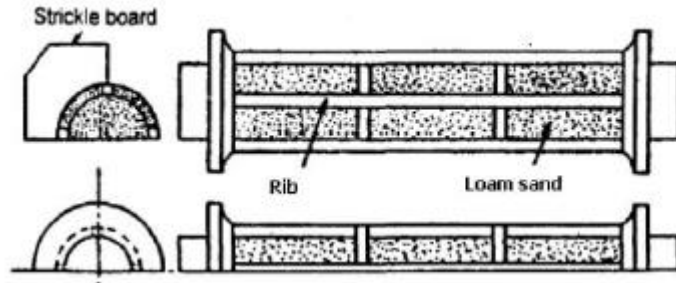

**6. Sweep pattern:** A sweep is a section or board (wooden) of proper contour that is rotated about one edge.

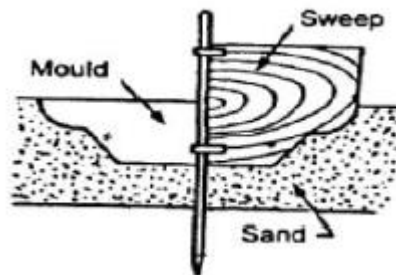

**7. Loose piece pattern:** Some patterns usually single piece are made to have loose pieces in order to enable their easy with drawl from the mould.



**8. Segmental pattern:** The segmental pattern is in the form of a segment, and is used for moulding parts having circular shapes.

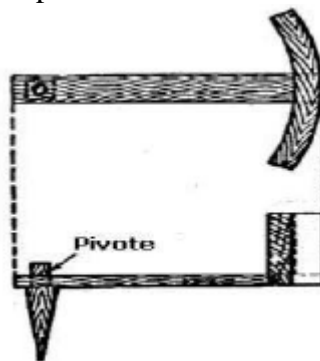

**b) List the various allowance provided on pattern. Explain any two in brief.**

4

(Name of any four allowances = 02 Marks, Explanation of any two= 02 Marks)

**Various allowance provided on pattern:**

- i. Shrinkage allowance
- ii. Draft allowance

02



- iii. Machining allowance
- iv. Distortion or camber allowance
- v. Shake allowance / rapping allowance

**i. Shrinkage Allowance:**

As metal solidifies and cools, it shrinks and contracts in size. To compensate for this, a pattern is made larger than the finished casting by means of a shrinkage or contraction allowance. To provide an allowance, a patternmaker uses shrink or contraction rule which is slightly longer than the ordinary rule of the same length. Different metals have different shrinkages; therefore, there is a shrink rule for each type of metal used in a casting.

It is also called as contraction allowance

When liquid metal starts to cool shrinkage is possible Gets shrink and reduces size of the component. To reduce above problem, allowance are provided on the pattern Patterns are made larger than actual size.

Different metal have different shrinkage

It has three forms

(a) Liquid Contraction (b)Solidifying Contraction (c)Solid Contraction

First two are reduced by gates and risers

Solid contraction can be reduced by providing more allowance on pattern

Following points causes shrinkage :

- Pouring Temperature of Molten Metal is Low
- Type of Mould Materials
- Design and Dimensions of Castings
- Type of Molten Metal

**ii. Draft allowance provided on pattern:**

When a pattern is drawn from a mould, there is always some possibility of injuring the edges of the mould. This danger is greatly decreased if the vertical surfaces of a pattern are appeared-inward slightly. This slight taper inward on the vertical surfaces of a pattern is known as the draft. Draft may be expressed in millimeter per meter on a side, or in degrees, and the amount needed in each case depends upon

- 1) length of the vertical side
- 2) Intricacy of the pattern, and
- 3) The method of moulding.

**iii. Machining Allowance:**

Rough surfaces of castings that have to be machined are made to dimensions somewhat over those indicated on the finished working drawings. The extra amount of metal provided on the surfaces to be machined is called machine finish allowance and the edges of these surfaces are indicated by a finish mark V, or F.

The amount that is to be added to the pattern depends upon

- (1) the kind of metal to be used
- (2) the size and shape of the casting and
- (3) Method of moulding.

**iv. Distortion or Camber Allowance:**

*Explanation  
of any two=  
02 Marks*



**MODEL ANSWER**

**WINTER- 18 EXAMINATION**

**Subject Title: Materials and Manufacturing Processes**

Subject Code:

**17306**

Some castings, because of their size, shape and type of metal, tend to warp or distort during the cooling period. This is a result of uneven shrinkage and is due to uneven metal thickness or to one surface being more exposed than another, causing it to cool more rapidly. The shape of the pattern is thus bent in the opposite direction to overcome this distortion. This feature is called distortion or camber allowance.

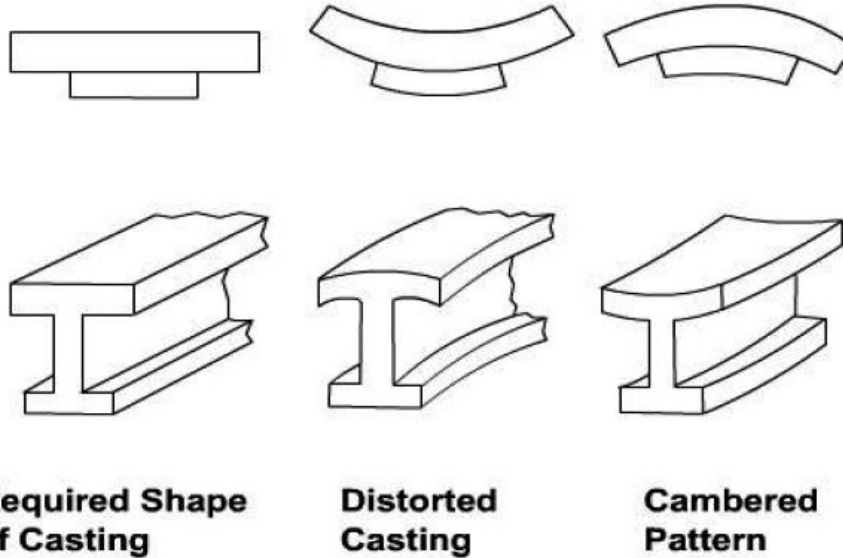

**5) Rapping or Shake allowance**

While withdrawing the pattern from the sand mould, the pattern is rapped all around the vertical faces. So that mould cavity get enlarge slightly, which facilitate its removal. Hence shake allowance must be considered by making the pattern slightly smaller.

**c) What are the different types of foundries? Enlist two advantages and disadvantages of foundry process.**

**4**

**Types of foundries:** (Any 04 – 2mark )

1. Jobbing foundry
2. Production foundry
3. Semi-production foundry
4. Captive foundry
5. Ferrous foundries
6. Non-ferrous foundries

**02**

**Advantages of foundry process:** (Any Two – 1 mark)

- i. It one of the most versatile manufacturing process.
- ii. Castings provide uniform directional properties.
- iii. Intricate shaped parts can be produced.
- iv. Very complicated parts can be cast in one piece.

**01**

**Disadvantages of foundry process:** (Any Two – 1 mark)

- i. It is only economical for mass production.
- ii. Sand casting process cannot produce parts in accurate sizes.

**01**



**MODEL ANSWER**

**WINTER- 18 EXAMINATION**

**Subject Title: Materials and Manufacturing Processes**

Subject Code:

**17306**

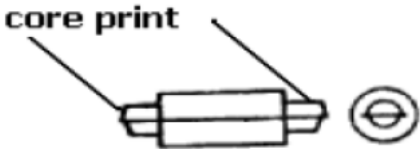
	<p>iii. Special casting processes are expensive. iv. In some casting process, skilled operators are required. v. Internal defects are not identified easily</p>	
<b>d)</b>	<p><b>Enlist with meaning the standard accepted colour codes used for pattern.</b> <i>(Meaning of any four colour codes-01 mark each)</i> <b>Standard accepted colour codes used for pattern:</b> The colour codes are given for identification of the parts of patterns and core boxes. 1. Surface to be left unfinished are to be painted <b>black</b> 2. Surface to be finished are painted by <b>red</b> colour. 3. Seats for loose pieces are marked by <b>red strips on yellow background.</b> 4. Core prints are painted by <b>yellow</b> colour. 5. Stop-offs is marked by diagonal <b>black strips on yellow background.</b></p>	<b>4</b>
<b>e)</b>	<p><b>State the different properties of moulding sand.</b> <b>Properties of moulding sand:(Any 04-01 mark each)</b> <b>1. Porosity/Permeability:</b> It is the property of the sand which allows the gases or steam to escape through the sand mould. <b>2. Flowability:</b> Flow ability of moulding sand refers to its ability to behave like a fluid, so that, when rammed, it will flow to all portions of a mould and pack all around the pattern and take up the required shape. <b>3. Collapsibility:</b> After the molten metal in the mould gets solidified, the sand mould must be collapsible so that free contraction of the metal occurs, and this would naturally avoid the tearing or cracking of the contracting metal. <b>4. Adhesiveness:</b> The sand particles must be capable of adhering to another body, i.e., they should cling to the sides of the moulding boxes. It is due to this property that the sand mass can be successfully held in a moulding box and it does not fall out of the box when it is removed. <b>5. Cohesiveness or strength:</b> This is the ability of sand particles to stick together. It is the property of the sand due to which rammed particles bind together firmly, so that pattern withdrawn from mould without damaging the mould surfaces or edges. <b>6. Refractoriness:</b> The sand must be capable of withstanding the high temperature of the molten metal without fusing.</p>	<b>4</b>
<b>f)</b>	<p><b>What is core print? Explain any two types of core print with neat sketch.</b> <b>Answer:</b> <i>(Core print = 02 Marks, Explanation of any two types= 02 Marks)</i> <b>Core print:</b> For supporting the cores in the mould cavity, an impression in the form of a recess is made in the mould with the help of a projection suitably placed on the pattern. This projection on the pattern is known as the core print. A core print is, therefore, an added projection on a pattern, and it forms a seat which is used to support and locate the core in the mould. There are several types of core prints, viz., horizontal or parting line core print, vertical or cope and drag core print, balancing core print, cover or hanging core-print, wing or drop core-print</p>	<b>04</b>
		<p><b>02</b></p> <p><b>(Any two)</b> <b>½ mark for sketch, ½</b></p>



**MODEL ANSWER**

WINTER- 18 EXAMINATION

Subject Title: Materials and Manufacturing Processes

Subject Code:

17306

(Any 02 types of cores with sketch-2 marks)

**Horizontal cores:** The most common type is the horizontal core. The core is usually cylindrical in form and is laid horizontally at the parting line of the mould. The ends of the core rest in the seats provided by the core prints on the pattern.

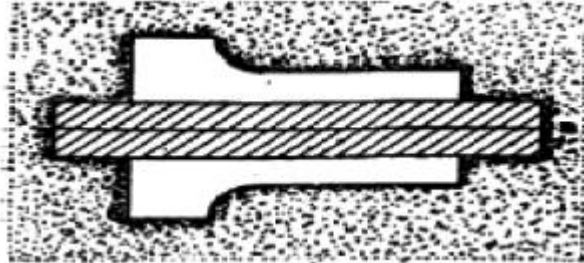

**Vertical core:** This is placed in a vertical position both in cope and drag halves of the mould. Usually top and bottom of the core are provided with a taper, but the amount of taper on the top is greater than that at the bottom.

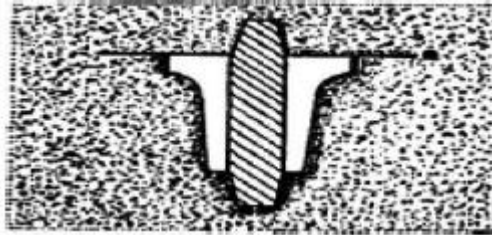

**Balanced core:** When the casting is to have an opening only one side and only one core print is available on the pattern a balanced core is suitable. The core print in such cases should be large enough to give proper bearing to the core. In case the core is sufficiently long, it may be supported at the free end by means of a chaplet.

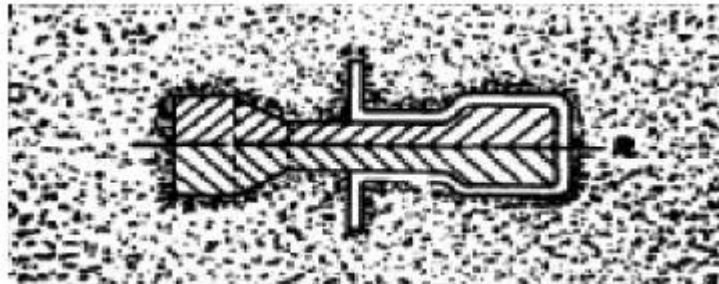

**Hanging and cover core:** If the core hangs from the cope and does not have any support at the bottom of the drag, it is referred to as a hanging core. In this case, it may be necessary to fasten the core with a wire or rod that may extend through the cope.

**mark for  
explanation**

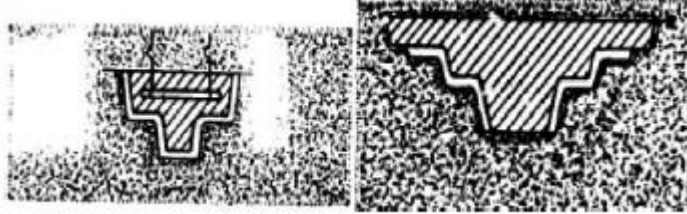

04 Attempt any FOUR of the following

16

a) Enlist the different moulding process. Explain shell moulding process with neat sketch.

4

**Different moulding process** (Any 4 types – 1 mark, figure 1 Mark and explanation -2 Mark )

**A. Different Moulding process as follows:**

- 1) Hand moulding
- 2) Machine moulding

**B. According to the method used:**

- 1) Floor moulding
- 2) Bench moulding
- 3) Pit moulding
- 4) Plate moulding
- 5) Sweep moulding

**C. According to the type of material: -**

- 1. Green sand moulding
- 2. Skin dried moulding
- 3. Dry sand moulding
- 4. Core sand moulding
- 5. Loam moulding

01

**Shell moulding**, also known as **shell-mould casting** is an expendable mold casting process that uses a resin covered sand to form the mold. As compared to sand casting, this process has better dimensional accuracy, a higher productivity rate, and lower labor requirements. It is used for small to medium parts that require high precision. Shell mold casting is a metal casting process similar to sand casting, in that molten metal is poured into an expendable mold. However, in shell mold casting, the mold is a thin-walled shell created from applying a sand-resin mixture around a pattern. The pattern, a metal piece in the shape of the desired part, is reused to form multiple shell molds. A reusable pattern allows for higher production rates, while the disposable molds enable complex geometries to be cast. Shell mold casting requires the use of a metal pattern, oven, sand-resin mixture, dump box, and molten metal.

02

01



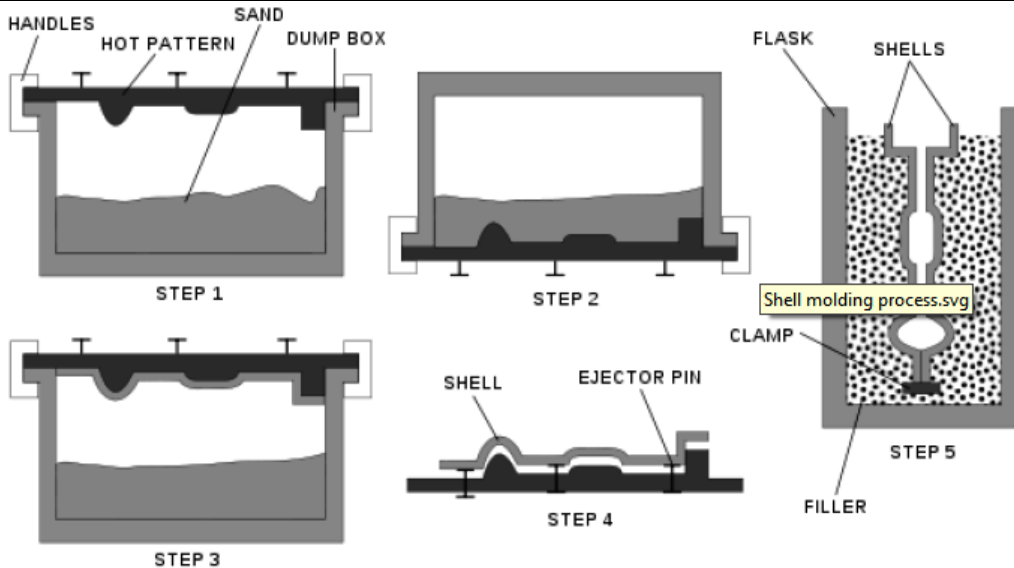

**Pattern creation** - A two-piece metal pattern is created in the shape of the desired part, typically from iron or steel. Other materials are sometimes used, such as aluminum for low volume production or graphite for casting reactive materials.

**Mold creation** - First, each pattern half is heated to 175-370 °C (350-700 °F) and coated with a lubricant to facilitate removal. Next, the heated pattern is clamped to a dump box, which contains a mixture of sand and a resin binder. The dump box is inverted, allowing this sand-resin mixture to coat the pattern. The heated pattern partially cures the mixture, which now forms a shell around the pattern. Each pattern half and surrounding shell is cured to completion in an oven and then the shell is ejected from the pattern.

**Mold assembly** - The two shell halves are joined together and securely clamped to form the complete shell mold. If any cores are required, they are inserted prior to closing the mold. The shell mold is then placed into a flask and supported by a backing material.

**Pouring** - The mold is securely clamped together while the molten metal is poured from a ladle into the gating system and fills the mold cavity.

**Cooling** - After the mold has been filled, the molten metal is allowed to cool and solidify into the shape of the final casting.

**Casting removal** - After the molten metal has cooled, the mold can be broken and the casting removed. Trimming and cleaning processes are required to remove any excess metal from the feed system and any sand from the mold.

**b) Draw a neat sketch of gating system. State the following terms: (i) Runner (ii) Pouring basin**

**4**

*(Figure = 02 Marks, Explanation of two terms = 02 Marks)*

**i. Runner:** In large castings, molten metal is usually carried from the sprue base to several gates around the cavity through a passageway called the runner. The runner is generally preferred in the drag, but it may sometimes be located in the cope, depending on the shape of the casting.

**01**

**ii. Pouring cups or basins:** This part of the gating system is made on or in the top of the mould. Sometimes, a funnel-shaped opening which serves as pouring basin is made at the top of the sprue in the cope.

**01**



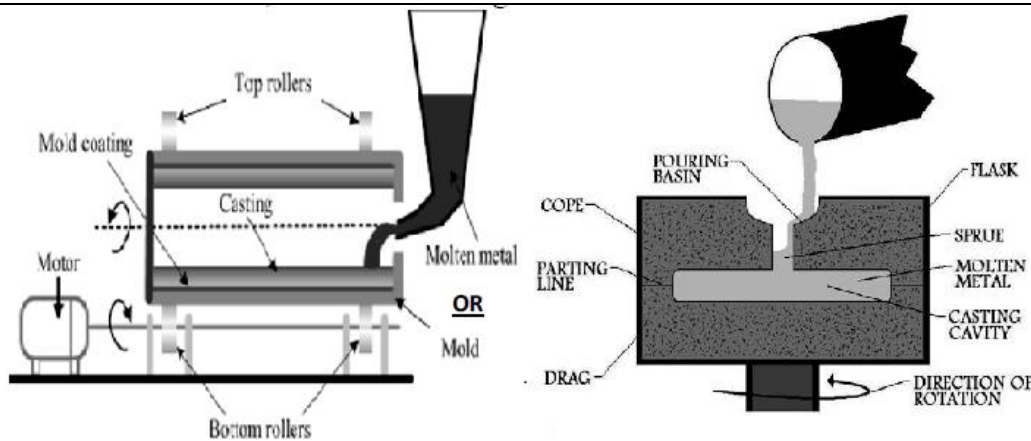

02

**d) Explain any two defects in casting with its causes and remedies.**

**4**

*(One Casting Defect with sketch, it's causes & it's remedies = 02 Mark each.)*

**1. Shifts:** This is an external defect in a casting.

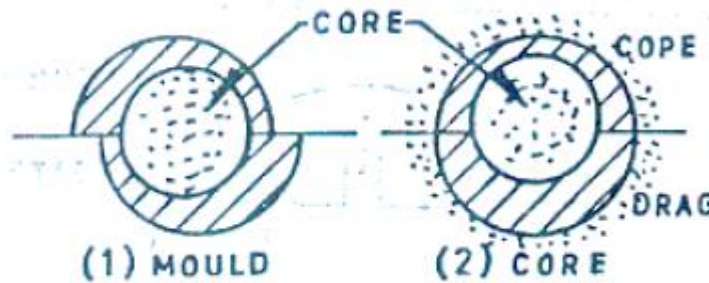

**Cause:**

Due to core misplacement or mismatching of top and bottom parts of the casting usually at a parting line. Misalignment of flasks is another likely cause of shift.

**Remedy:**

By ensuring proper alignment of the pattern or die part, moulding boxes, correct mounting of patterns on pattern plates, and checking of flasks, locating pins, etc. before use.

**2. Warpige:** Warpige is unintentional and undesirable deformation in a casting that occurs during or after solidification.

**Cause:**

Due to different rates of solidification different sections of a casting, stresses are set up in adjoining walls resulting in warpige in these areas. Large and flat sections or intersecting sections such as ribs are particularly prone to warpige.

**Remedy:**

Is to produce large areas with wavy, corrugated construction, or add sufficient ribs or rib-like shapes, to provide equal cooling rates in all areas; a proper casting design can go a long way in reducing the warpige of the casting.

**2. Swell:** A swell is an enlargement of the mould cavity by metal pressure, resulting in localized or overall enlargement of the casting.

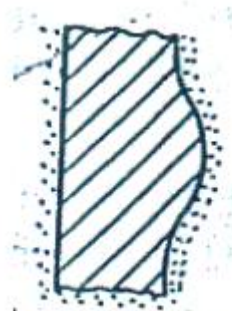

Figure: Swell.

**Cause:**

This is caused by improper or defective ramming of the mould.

**Remedy:**

To avoid swells, the sand should be rammed properly and evenly.

**4. Blowholes:** Blow holes are smooth, round holes appearing in the form of a cluster of a large number of small holes below the surface of a casting. These are entrapped bubbles of gases with smooth walls.

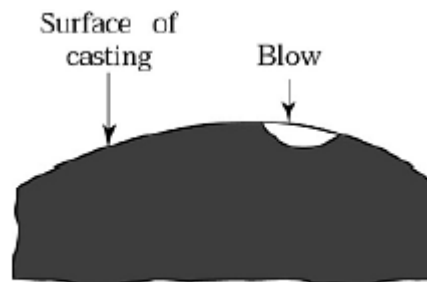

Figure: Blow hole.

**Cause:**

Excessive moisture in the sand, or when permeability of sand is low, sand grains are too fine, sand is rammed too hard, or when venting is insufficient.

**Remedy:**

To prevent blowholes, the moisture content in sand must be well adjusted, sand of proper grain size should be used, ramming should not be too hard and venting should be adequate.

**5. Drop:** A drop occurs when the upper surface of the mould cracks, and pieces of sand fall into the molten metal.

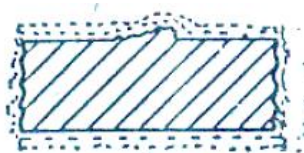

Fig. Drop

**Cause:**

This is caused by low strength and soft ramming of the sand, insufficient fluxing of molten metal and insufficient reinforcement of sand projections in the cope.

**Remedy:**

The above factors are eliminated to avoid drop.

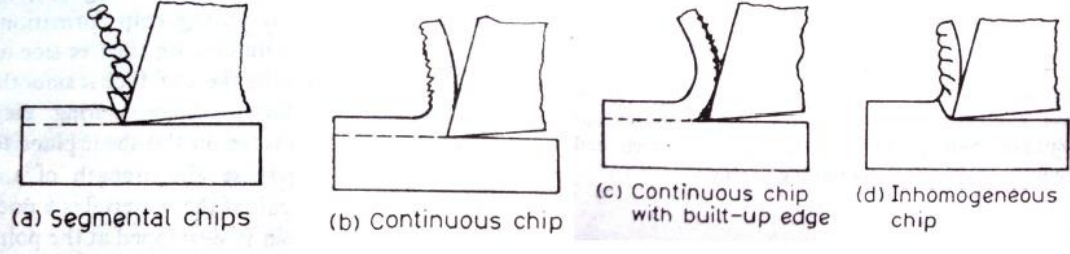
	<p><b>e) Explain different types of chips observed while machining.</b></p>	<b>4</b>
	<p><i>(Explanation of each type with neat sketch - 01 mark ,)</i></p> <p><b>Different types of chips:</b></p> <p><b>1. Discontinuous or segmental chips:</b>          These types of chips are usually produced when cutting more brittle material like grey cast iron, bronze and hard brass. Machining of brittle materials produce these types of chips. Small fragments are produced because of lack in ductility of material. Friction between tool and chip reduces, resulting in better surface finish.</p> <p><b>2. Continuous chips:</b>          This type of chip is the most desirable, since it is stable cutting, resulting in generally good surface finish. Machining of ductile materials produce these types of chips. Continuous fragments are produced because of high ductility of material. Chips are difficult to handle.</p> <p><b>3. Continuous chips with built-up edge (BUE):</b>          When machining ductile material, conditions of high local temperature and extreme pressure in the cutting zone and also high friction in the tool-chip interface, may cause the work material to adhere or weld to the cutting edge of the tool forming BUE. BUE changes its size during cutting operation. It protects the cutting edge but it changes the geometry of the tool.</p> <p><b>4. Non homogeneous chip:</b></p> <ul style="list-style-type: none"> <li>• The temperatures generated in the machining zone control the rate of tool wear, the practical cutting speed and the MRR</li> <li>• It is important to understand the factors which influence the generation of heat, flow of heat and the temperature distribution in the tool and work material near the cutting edge</li> <li>• Temperature is developed in three types of zones as             <ol style="list-style-type: none"> <li>1. Shear zone</li> <li>2. Tool-chip interface</li> <li>3. Tool-work interface</li> </ol> </li> </ul> <div style="text-align: center;">  <p>(a) Segmental chips      (b) Continuous chip      (c) Continuous chip with built-up edge      (d) Inhomogeneous chip</p> </div>	
	<p><b>f) Draw a neat sketch of three jaw chuck and explain why it is more convenient than four jaw chuck</b></p>	<b>4</b>
	<p><i>( Neat sketch of three jaw chuck -2 Marks, explanation-2 Marks)</i></p> <p><b>Three jaw self-centering chuck:</b> The three jaws fitted in the three slots may be made to slide at the same time by an equal amount by rotating any one of the three pinions by a chuck key. This type of chuck is suitable for holding and rotating regular shaped workpieces like round or hexagonal rods about the axis of the lathe. Workpieces of irregular shapes cannot be held by this chuck.</p>	

Three jaw chuck is convenient because is self-centring. The job is centred automatically. Marking gauge and other accessories are not needed for centering hence setup time of the job is greatly reduced. Semi skilled worker can handle this chuck. It also can hold hexagonal bar-stock. It is quick and easy to use.

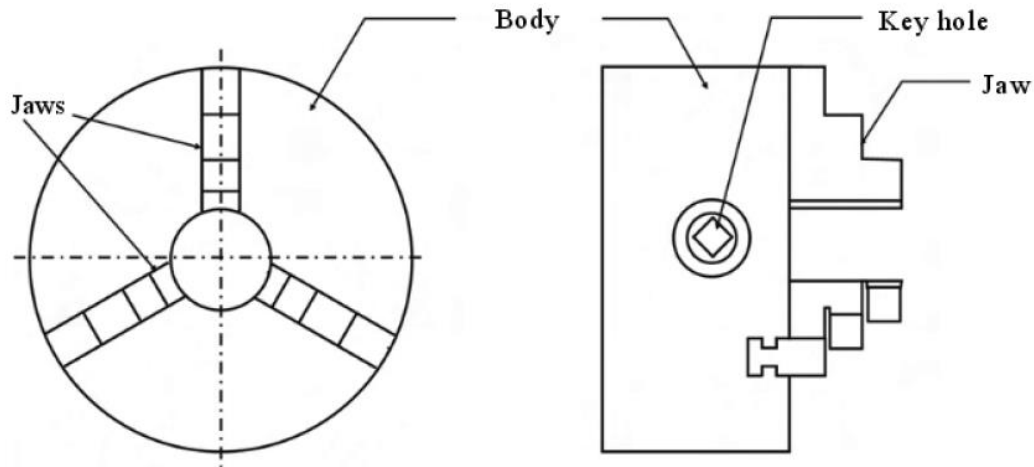

Fig Three jaw chuck

5 Attempt any four of the following:

16

a) Draw a neat sketch of single point cutting tool and show the different parts and angle on it.

04

Ans: Sketch 02 marks, Labeling 02 marks

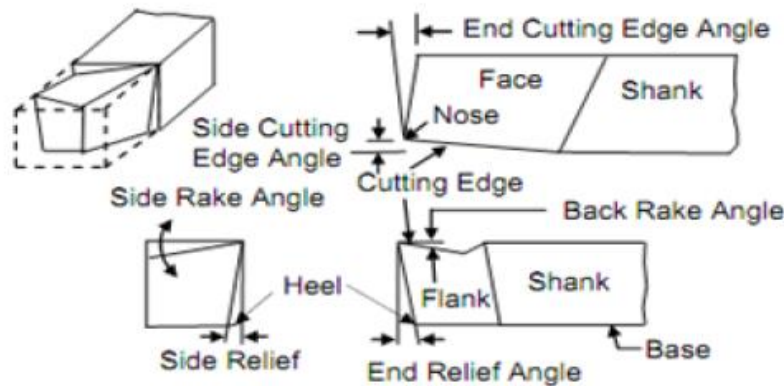
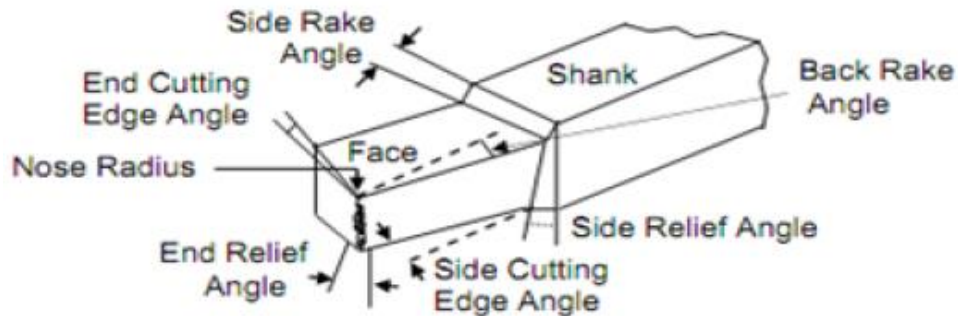

Fig. Single Point Cutting Tool

OR

04



**Fig. Single Point Cutting Tool**

	<b>b)</b>	<b>What are different types of cutting tool materials? State their specific use.</b>	<b>04</b>
		<p><b>Answer:</b> Different types of tool materials: <i>(Any 02- 01 mark for material and 01 mark for use)</i></p> <ol style="list-style-type: none"> <li><b>High-speed steels:</b> These steels are called as HSS because these steels cut material at high speeds and retain their hardness even at high temperature. It consists of iron and carbon with differing amounts of alloying elements such as tungsten, chromium, vanadium and cobalt. <b>Specific use:</b> 18:4:1 HSS tool is used to manufacture drills, reamers, end mill cutters and taps.</li> <li><b>Stellites:</b> Stellite is the trade name of a nonferrous cast alloy composed of cobalt, chromium and tungsten. It is shaped by casting from which it gets cutting properties. <b>Specific use:</b> Stellite is used in the manufacture of turning tools for lathes, slitting cutters.</li> <li><b>Cemented carbides:</b> The basic ingredient of most cemented carbides is tungsten carbide which is extremely hard. Pure tungsten powder is mixed under high heat, at about 1500 OC, with pure carbon (lamp black) in the ratio of 94 per cent and 6 per cent by weight. The new compound, tungsten carbide, is then mixed with cobalt until the mass is entirely homogeneous. <b>Specific use:</b> Carbide tips for face mill cutters, carbide drills in VMC machines.</li> <li><b>Diamond:</b> The diamonds used for cutting tools are industrial diamonds, which are naturally occurring diamonds containing flaws and therefore of no value as gemstones. Alternatively they can be also artificial. <b>Specific use:</b> These are suitable for cutting very hard materials such as glass, plastics and ceramics.</li> </ol>	<p><b>01</b></p> <p><b>01</b></p> <p><b>01</b></p> <p><b>01</b></p> <p><b>(Any two: 1 mark for material , 1 mark for use)</b></p>
	<b>c)</b>	<b>State four properties and purposes of cutting fluid.</b>	<b>04</b>
		<p><b>Properties of cutting fluid:</b> <i>(Any 04- 1/2 mark each)</i></p> <ol style="list-style-type: none"> <li>High heat absorption</li> <li>Good lubricating qualities to produce low coefficient of friction</li> <li>Low viscosity to permit free flow of liquid</li> <li>Non-corrosive to the work or the machine</li> <li>High flash point so as the eliminate the hazards of fire</li> <li>Odorless ,so as not to produce any bad smell</li> <li>Harmless to the skin of operator</li> <li>Transparency so that the cutting action of the tool may be observed</li> </ol>	<b>02</b>



**MODEL ANSWER**

**WINTER- 18 EXAMINATION**

**Subject Title: Materials and Manufacturing Processes**

Subject Code:

**17306**

**Purpose of cutting fluid - (Any four ½ mark each)**

**Cutting fluids are used in machining:**

- 1) To cool the tool
- 2) To cool the work piece.
- 3) To lubricate & reduce friction.
- 4) To improve surface finish.
- 5) To protect the finished surface from corrosion.
- 6) To cause chips break up into small parts.
- 7) To wash the chips away from the tool.

**02**

**d) Draw block diagram of lathe machine. Write function of tail stock and carriage.**

**04**

**Ans: Function of tailstock:**

- 1) To support the other end of the work when it is being machined between the center
- 2) It holds a tool for performing operation such as drilling, reaming etc.

**Function of carriage:** The carriage of a lathe has several parts that serves to support, move and control the cutting tool.

**01**

**01**

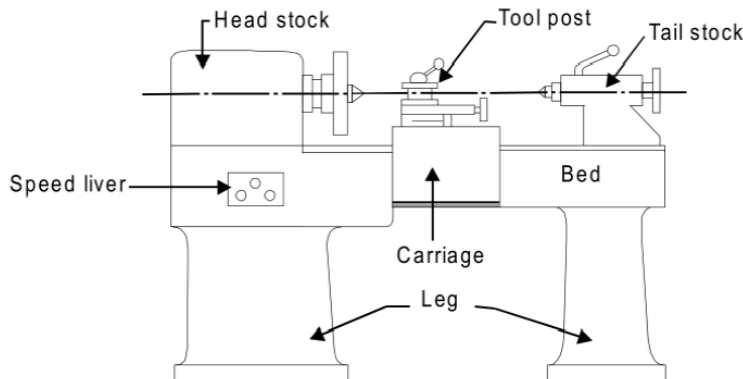

**Fig. Block diagram of lathe machine**

**02**

**e) State any four accessories used on lathe. Explain any two accessories.**

**04**

**Answer:** Accessories of lathe:(Any 04: ½ mark each)

1. Centre
2. Chuck
3. Face plate
4. Angle plate
5. Mandrel
6. Rests
7. Carriers
8. Catch plates
9. Collets

**02**

The lathe accessories: (Any 02 : ½ mark for sketch - ½ mark for explanation)

**1. Centres:**

- a. There are two types of centres i.e., live centre and dead centre.

Any 02 : ½ mark for sketch - ½ mark for explanation



- b. A centre which fits into the headstock spindle and revolves with the work is called live centre.  
c. The centre which is used in a tailstock spindle and does not revolve is called dead centre.



(a) Standard centre (b) Half centre

**2. Chucks:**

- a. It is an important device used for holding and rotating the workpiece in lathes.  
b. The work pieces which are too short to be held between centres are clamped in a chuck.  
c. It is attached to the lathe spindle by means of two bolts with the back plate screwed on to the spindle nose.  
d. There are many types of the chuck, but the following two are commonly used.

- i) Three jaw universal chuck: The three jaw universal chuck, as shown in Fig. (a) is also called self-centering chuck or scroll chuck. Thus chuck is used for holding round and hexagonal work.

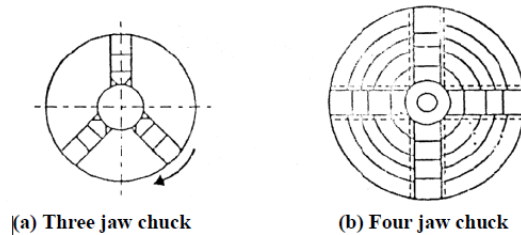

(a) Three jaw chuck (b) Four jaw chuck

- ii) Four jaw independent chuck: 1. The four jaw independent chuck, as shown in Fig. (b) has four reversible jaws, each of which may be independently adjusted to accommodate the work it supports. 2. This type of chuck can hold square, round and irregular shape of work in either a concentric or eccentric position. The other types of the chucks are iii) combination chucks, iv) magnetic chuck, v) collet chuck, vi) drill chuck, and vii) air or hydraulic chuck

**3. Lathe dog or carrier:**

- a. The work placed on a mandrel or held between centres is rotated positively by clamping the dog or carrier to the end of the work.  
b. This is engaged with a pin attached to the drive plate or face plate.  
c. The lathe dog or carrier may be of straight type or bent type as shown in Fig. (a) and (b) respectively.

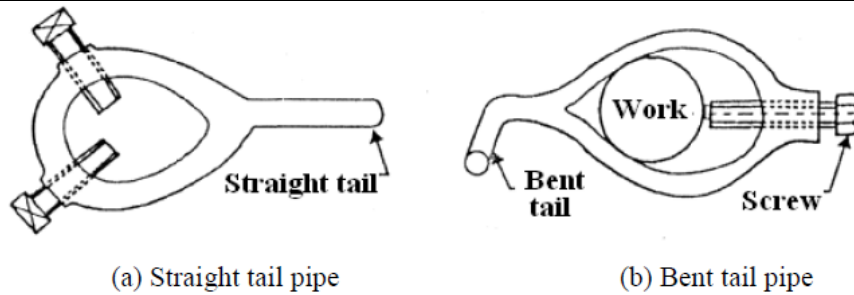

**4. Drive plate:**

- The drive plate, as shown in Fig. is a circular plate which is bored out and threaded so that it can be attached to the spindle nose.
- It also carries a hole for the pin which is used only when the work is held in a lathe dog having straight tail. When bent-tail dog is used, this pin is taken out and the bent portion of the tail is inserted into the hole

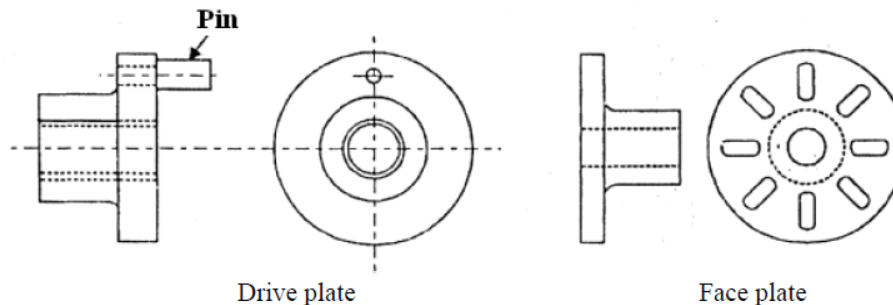

**5. Faceplate:**

- The face plate, as shown in Fig. is similar to drive plate except that it is larger in diameter.
- It contains more open slots or T-slots so that bolts may be used to clamp the workpiece to the face of the plate.
- The face plate is used for holding work pieces which can not be conveniently held in a chuck.

**6. Angle plate:**

- An angle plate is simply a cast iron plate with two faces planed at right angles to each other and having slots in various positions for the clamping bolts.
- It is always used with the face plate for holding such parts which can not be clamped against the vertical surface of the face plate.

**7. Mandrels:**

- The lathe mandrel is a cylindrical bar with centre hole at each end. It is used to hold hollow work pieces to machine their external surface.

b. The work revolves with the mandrel which is mounted between the centres of the lathe. The various types of mandrels used for different classes of work are shown in Fig.

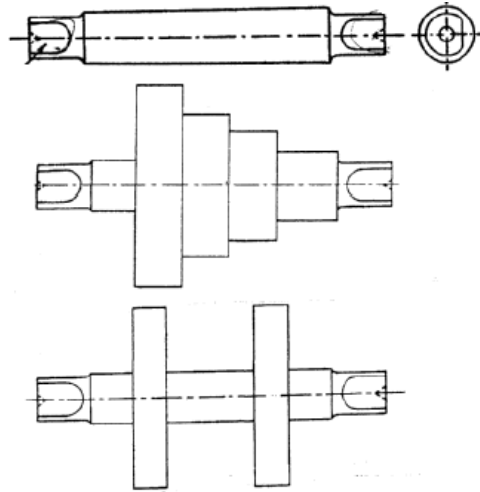

Plain mandrel, Step mandrel and Collar mandrel

**f) What is working principle of lathe? How lathe machines are classified.**

**04**

**Ans:** (sketch 01 mark, working principle 01 mark, classification 02 marks)

**Working Principle of a Lathe:**

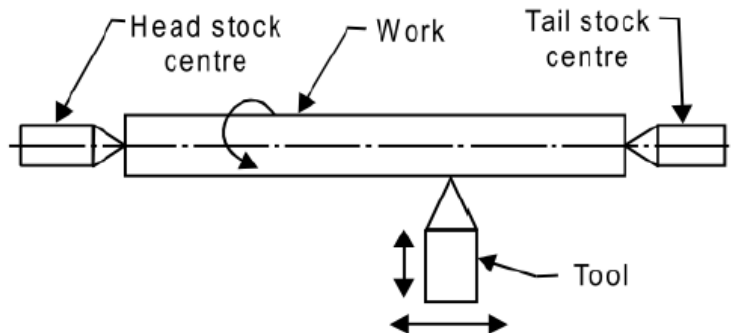

**01**

The working principle of a lathe is shown in Fig.

1. In a lathe, the workpiece is held in a chuck or between centres and rotated about its axis at a uniform speed.
2. The cutting tool held in the tool post is fed into the workpiece for a desired depth and in the desired direction (i.e., in the linear, transverse or lateral direction).
3. Since there exists a relative motion between the workpiece and the cutting tool therefore the material is removed in the form of chips and the desired shape is obtained.

**01**

Lathes are classified according to: (Any 04 main points: ½ marks each)

**1) Speed lathe.**



**MODEL ANSWER**

**WINTER- 18 EXAMINATION**

**Subject Title: Materials and Manufacturing Processes**

Subject Code:

**17306**

	<p>i. Wood working ii. Centering iii. Polishing iv. Spinning <b>2) Engine or centre lathe.</b> i. Belt drive ii. Individual motor drive iii. Gear head lathe <b>3) Bench lathe.</b> <b>4) Tool room lathe.</b> <b>5) Capstan and turret lathe.</b> <b>6) Automatic lathes.</b> <b>7) Special purpose lathes.</b> i. Gap bed lathe ii. Wheel lathe iii. Duplicating lathe iv. T – lathe</p>	<p><b>02</b></p>
<b>6</b>	<b>Attempt any FOUR of the following:</b>	<b>16</b>
a)	<b>Draw a neat sketch of column and knee type milling machine and explain function of any two parts.</b>	<b>04</b>
<b>Ans:</b>	<p><b>Column and Knee type milling machine:</b> (<i>Functions - 2 marks, Sketch - 2 marks</i>)</p> <p><b>Function of Parts:</b> (<i>Any 02 - 1 mark each</i>)</p> <ol style="list-style-type: none"><li><b>1. Base:</b> It is a heavy casting on which column and other parts are mounted. It may be bolted to floor strongly.</li><li><b>2. Column:</b> there are guide ways on the front face of the column, on which the knee slides. It houses power transmission units such as gears, belt drives and pulleys to give rotary motion to the arbor. The drive mechanisms are also used to give automatic feed to the handle and table.</li><li><b>3. Knee:</b> It supports the saddle, table, work piece and other clamping devices. It moves on the guide ways of column. It resists the deflection caused by the cutting forces on the work piece.</li><li><b>4. Saddle:</b> It is mounted on the knee and can be moved by hand wheel or by power. The direction of travel of the saddle is restricted towards or away from the column face.</li><li><b>5. Table:</b> It is mounted on the saddle and can be moved by a hand wheel or by power. Its top surface is machined accurately to hold the work piece and other holding devices. It moves perpendicular to the direction of saddle movement.</li><li><b>6. Arbor:</b> Its one end is attached to the column and the other end is supported by an over arm. It holds and drives different types of milling cutters.</li><li><b>7. Spindle:</b> It gets power from the gears, belt drives, to drive the motor. It has provision to add or remove milling cutters on to the arbor</li></ol>	<p><b>(functions of any two parts 01 mark each)</b></p>



**MODEL ANSWER**

**WINTER- 18 EXAMINATION**

**Subject Title: Materials and Manufacturing Processes**

Subject Code:

**17306**

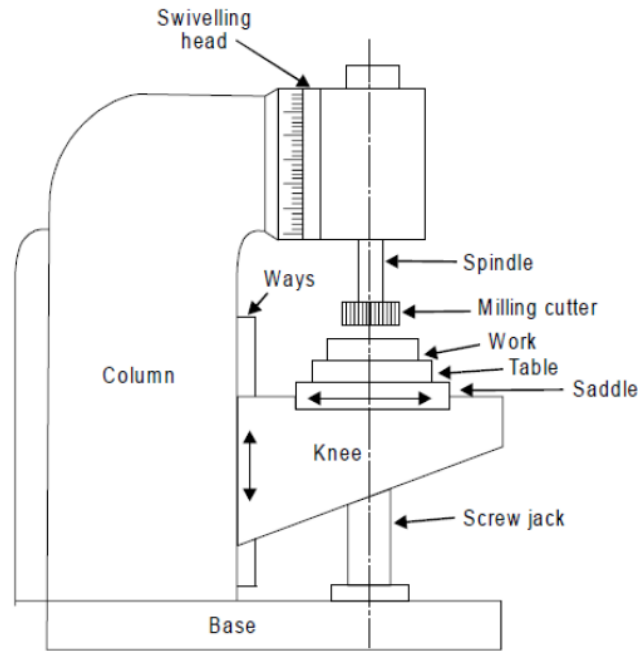

Figure: Column and Knee type milling machine

02

**b) Explain end milling operation with neat sketch.**

04

**Ans:** (Sketch 02 marks, explanation 02 marks)

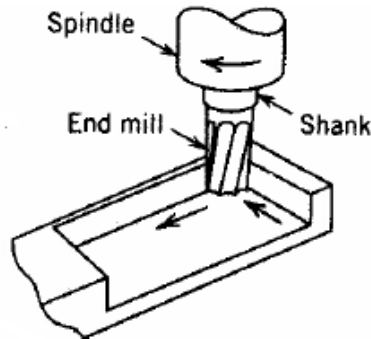

Figure: End Milling Operation

02

**End Milling Operation:** End milling operation produces flat vertical surfaces, flat horizontal surfaces and other flat surfaces making an angle from table surface using milling cutter named as end mill. This operation is preferably carried out on vertical milling machine.

02

**c) What are different standard milling cutters? Describe suitability of any two.**

02

**Ans:** **Classification of Standard milling cutter:** (Any 04 -2 marks)

- 1) Plain milling cutter
  - a) Light duty
  - b) Heavy duty
  - c) Helical

02



- 2) Side milling cutter
  - a) Plain
  - b) Staggered teeth
  - c) Half
  - d) Interlocking
- 3) Metal slitting saw
  - a) Plain
  - b) Staggered teeth
- 4) Angle milling cutter
  - a) Single
  - b) Double
- 5) End milling cutter
  - a) Taper shank
  - b) Straight shank
  - c) Shell
- 6) T-slot milling cutter
- 7) Woodruff key slot milling cutter
- 8) Fly cutter
- 9) Formed cutter
  - a) Convex
  - b) concave
  - c) corner rounding
  - d) gear cutter
  - e) thread milling cutter
- 10) Tap & reamer cutter
- 11) Face milling cutter

**Suitability of milling cutter:** (Any 04 – 2 marks )

1. Plain milling cutter: Suitable for face milling operation.
2. Side milling cutter: Suitable for machining of side faces.
3. Metal slitting saw: Suitable for parting off surfaces.
4. Angle milling cutter: Suitable for producing angular surfaces.
5. End milling cutter: Suitable for producing slots in work piece.
6. T-slot milling cutter: Suitable for T-slot operation.
7. Woodruff key slot milling cutter: Suitable for machining keyway

**02**

**d) List the parts of drilling machine. Write function of any two parts.**

**04**

**Ans:** Parts of Drilling machine: ( any four parts-02 marks )

- i) Base
- ii) Spindle



	<p>iii) Drill Chuck iv) Head v) Adjustable Table vi) Column</p> <p>Functions of parts: (Any 02)</p> <p>i. Base: It supports the column, which in turn, support the table and head etc. ii. Spindle: It is made up of alloy steel. It rotate as well as moves up and down in a sleeve iii. Drill chuck : It is held at the end of the drill spindle and in turns it holds the drill bit or tool. iv. Head :it contains the electric motor ,V pulley &amp; v-belt which transmit rotary motion to drill spindle at number of speeds v. Adjustable Table: It is supported on the column of the drilling machine and can be moved vertically and horizontally. It also carries slot for bolt clamping vi. Column: It is vertical round or box section, which rests on the base and supports the head and the table.</p>	<p>02</p> <p>02</p>
e)	<b>How drilling machines are classified? State various operations performed on drilling machine.</b>	04
Ans:	<p><b>Classification of drilling machine:</b> ( Any four -2 marks)</p> <ol style="list-style-type: none"><li>1. Portable drilling machine</li><li>2. Bench drilling machine</li><li>3. Sensitive drilling machine</li><li>4. Upright or column drilling machine</li><li>5. Radial drilling machine</li><li>6. Gang drilling machine</li><li>7. Multi-spindle drilling machine</li><li>8. Vertical drilling machine</li><li>9. Automatic drilling machine</li><li>10. Deep hole drilling machine</li></ol> <p><b>Operation performed on drilling machine:</b> ( Any four -2 marks)</p> <ol style="list-style-type: none"><li>1) <b>Drilling operation:</b> It is the operation of producing a cylindrical hole by removing metal by the rotating edge of a cutting tool called the drill</li><li>2) <b>Reaming operation:</b> It is accurate way of sizing and finishing a hole which has been previously drilled.</li><li>3) <b>Boring:</b> Boring is a process of enlarging an existing hole by a single point cutting tool.</li><li>4) <b>Counter Bore:</b> This operation uses a pilot to guide the cutting action to accommodate the heads of bolts.</li><li>5) <b>Countersink:</b> Special angled cone shaped enlargement at the end of the hole to accommodate the screws.</li><li>6) <b>Tapping:</b> Tapping is the process by which internal threads are formed. It is performed either by hand or by machine.</li></ol>	<p>02</p> <p>02</p>



**MODEL ANSWER**

WINTER- 18 EXAMINATION

Subject Title: Materials and Manufacturing Processes

Subject Code:

17306

f)	<b>Explain with neat diagram any two lathe operations.</b>	<b>04</b>
Ans:	<p><b>Any two operations – Description 01 Mark each, 01 mark for Sketch</b></p> <p><b>The most common operations which can be carried out on a lathe are:</b></p> <ol style="list-style-type: none"><li>1) Facing,</li><li>2) Plain turning,</li><li>3) Step turning,</li><li>4) Taper turning,</li><li>5) Drilling,</li><li>6) Reaming,</li><li>7) Boring,</li><li>8) Undercutting,</li><li>9) Threading,</li><li>10) Knurling.</li></ol> <p><b>These operations are discussed as follows:</b></p> <p><b>1) Facing:</b> This operation is almost essential for all works. In this operation, as shown in Fig. the workpiece is held in the chuck and the facing tool is fed from the centre of the workpiece towards the outer surface or from the outer surface to the centre, with the help of a cross-slide.</p> <div data-bbox="267 1092 1218 1438" data-label="Image"><p>The image contains three diagrams illustrating lathe operations. The first diagram, labeled 'Facing', shows a cylindrical workpiece held in a chuck. A tool is positioned at the right end of the workpiece, ready to cut. The second diagram, labeled 'Plain turning', shows the workpiece held between centers. A tool is cutting the cylindrical surface. The third diagram, labeled 'step turning', shows the workpiece held in a chuck, with a tool cutting a step of a different diameter. Labels 'Chuck', 'Work', and 'Tool' are used to identify components in each diagram.</p></div> <p><b>2) Plain turning:</b> It is an operation of removing excess amount of material from the surface of the cylindrical workpiece. In this operation, as shown in Fig. the work is held either in (lie chuck or between centres and the longitudinal feed is given to the tool either by hand or power.</p> <p><b>3) Step turning:</b> It is an operation of producing various steps of different diameters in the workpiece, as shown in Fig. This operation is carried out in the similar way as plain turning.</p> <p><b>4) Taper turning:</b> It is an operation of producing an external conical surface on a workpiece. A small taper may be produced with the help of a forming tool or chamfering tool, but the larger tapers are produced by swiveling the compound rest, as shown in Fig. at the required angle or by offsetting the tailstock or by taper turning attachment.</p>	<p><b>Any two operations – Description 01 Mark each, 01 mark for Sketch</b></p>



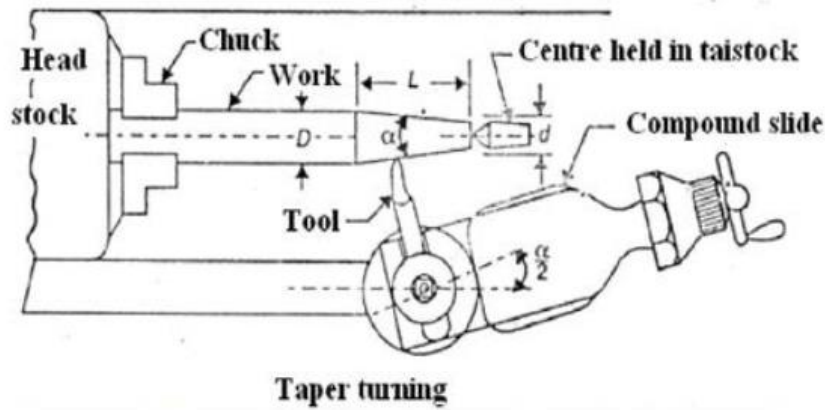

**5) Drilling:**

It is an operation of making a hole in a workpiece with the help of a drill. In this operation, as shown in Fig.5.18 the workpiece is held in a chuck and the drill is held in the tailstock. The drill is fed manually, into the rotating workpiece, by rotating the tailstock hand wheel.

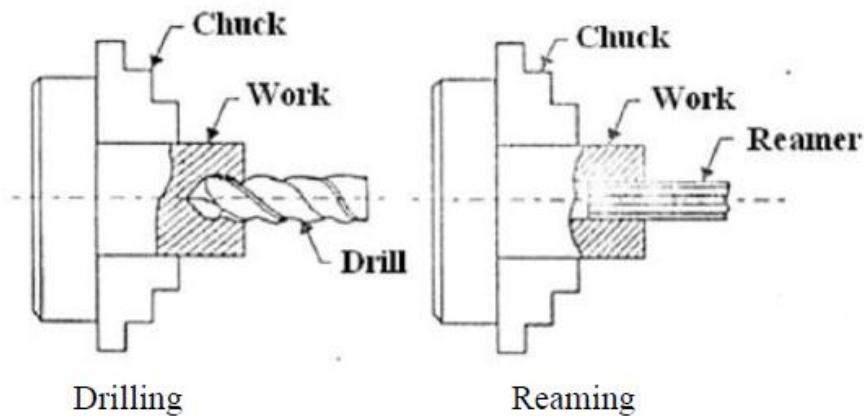

**6) Reaming:** It is an operation of finishing the previously drilled hole. In this operation, as shown in Fig. a reamer is held in the tailstock and it is fed into the hole in the similar way as for drilling.

**7) Boring:** It is an operation of enlarging of a hole already made in a workpiece. In this operation, as shown in Fig. a boring tool or a bit mounted on a rigid bar is held in the tool post and fed into the work by hand or power in the similar way as for turning.

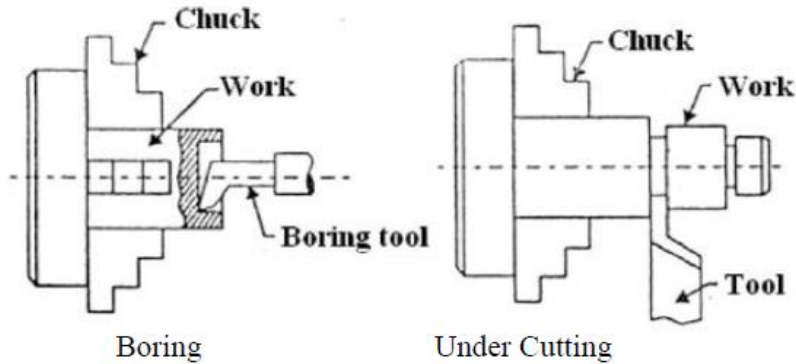

**8) Undercutting or Grooving:** It is an operation of reducing the diameter of a workpiece over a very narrow surface. In this operation, as shown in Fig. a tool of appropriate shape is fed into the revolving work up to the desired depth at right angles to the centre line of the workpiece

**9) Threading:** It is an operation of cutting helical grooves on the external cylindrical surface of workpiece. In this operation, as shown in Fig. the work is held in a chuck or between centers and the threading is fed longitudinally to the revolving work. The longitudinal feed is equal to the pitch of the thread to be cut.

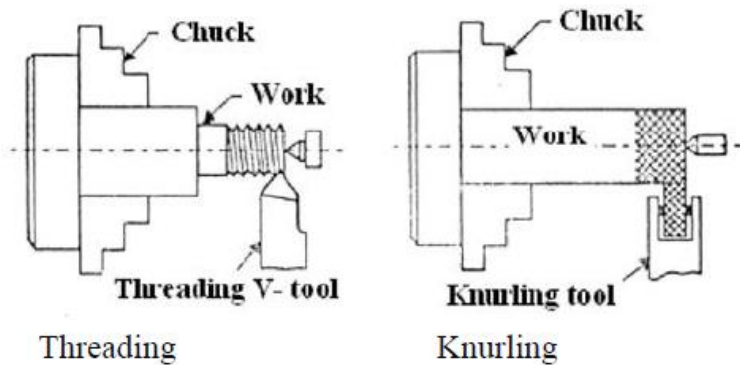

**10) Knurling:** It is an operation of providing knurled surface on the workpiece. In this operation, as shown in Fig. a knurled tool is moved longitudinally to a revolving workpiece surface. The projections on the knurled tool reproduce depressions on the work surface.